



650V SuperJunction Power MOSFET

Features

- Extremely Low Gate Charge
- Excellent Output Capacitance (C_{oss}) Profile
- Fast Switching Capability
- 100% UIS Tested, 100% R_g Tested
- Pb-free Lead Plating
- Halogen-free and RoHS-compliant

Product Summary

Parameter	Value	Unit
V_{DS}	650	V
$V_{GS(th), Typ}$	3.5	V
I_D (@ $V_{GS} = 10V$) ⁽¹⁾	12.0	A
$R_{DS(ON), Typ}$ (@ $V_{GS} = 10V$)	260	m Ω
$E_{oss@400V}$	4.59	μJ

Applications

- Telecom / Server Power Supplies
- Industrial Power Supplies
- UPS / Solar
- Lighting / Charger / Adapter

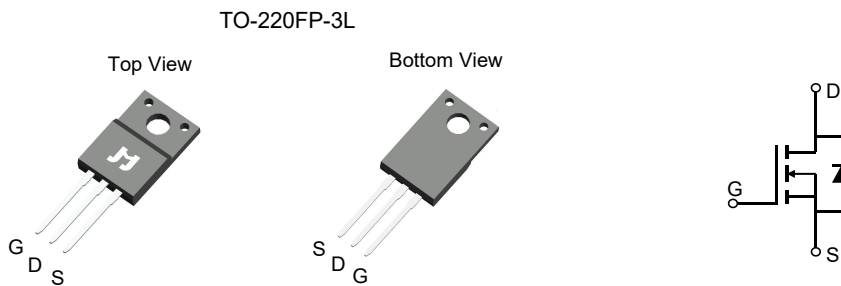

Ordering Information

Device	Package	# of Pins	Marking	MSL	T_J (°C)	Media	Quantity (pcs)
JMH65R290AF-U	TO-220FP-3L	3	H65R290A	NA	-55 to 150	Tube	50

Absolute Maximum Ratings (@ $T_A = 25^\circ C$ unless otherwise specified)

Parameter	Symbol	Value	Unit
Drain-to-Source Voltage	V_{DS}	650	V
Gate-to-Source Voltage	V_{GS}	± 25	V
Continuous Drain Current ⁽¹⁾	I_D	$T_C = 25^\circ C$	12.0
		$T_C = 100^\circ C$	8.0
Pulsed Drain Current ⁽²⁾	I_{DM}	48	A
Avalanche Current ⁽³⁾	I_{AS}	5.2	A
Avalanche Energy ⁽³⁾	E_{AS}	135	mJ
Power Dissipation ⁽⁴⁾	P_D	$T_C = 25^\circ C$	31
		$T_C = 100^\circ C$	13
Junction & Storage Temperature Range	T_J, T_{STG}	-55 to 150	$^\circ C$

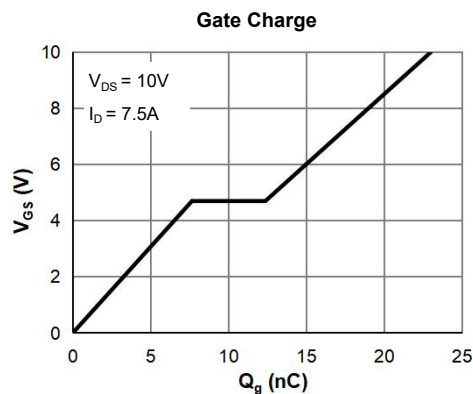
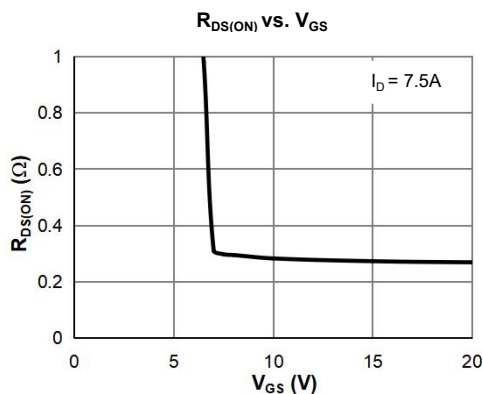

**Electrical Characteristics** (@ $T_J = 25^\circ\text{C}$ unless otherwise specified)

Parameter	Symbol	Conditions	Min.	Typ.	Max.	Unit
STATIC PARAMETERS						
Drain-Source Breakdown Voltage	$V_{(BR)DSS}$	$I_D = 250\mu\text{A}, V_{GS} = 0\text{V}$	650			V
Zero Gate Voltage Drain Current	I_{DSS}	$V_{DS} = 650\text{V}, V_{GS} = 0\text{V}$			1.0	μA
Gate-Body Leakage Current	I_{GSS}	$V_{DS} = 0\text{V}, V_{GS} = \pm 20\text{V}$			± 100	nA
Gate Threshold Voltage	$V_{GS(th)}$	$V_{DS} = V_{GS}, I_D = 250\mu\text{A}$	2.5	3.5	4.5	V
Static Drain-Source ON-Resistance	$R_{DS(ON)}$	$V_{GS} = 10\text{V}, I_D = 7.5\text{A}$		260	290	m Ω
Diode Forward Voltage	V_{SD}	$I_S = 1\text{A}, V_{GS} = 0\text{V}$		0.75		V
Diode Continuous Current	I_S	$T_C = 25^\circ\text{C}$			10	A
DYNAMIC PARAMETERS ⁽⁵⁾						
Input Capacitance	C_{iss}	$V_{GS} = 0\text{V}, V_{DS} = 325\text{V}, f = 1\text{MHz}$		1056		pF
Output Capacitance	C_{oss}			31		pF
Effective output capacitance, energy related	$C_{o(er)}$	$V_{GS}=0\text{V}, V_{DS}=0\dots 400\text{V}$		57		pF
Effective output capacitance, time related	$C_{o(tr)}$	$ID=\text{constant}, V_{GS}=0\text{V}, V_{DS}=0\dots 400\text{V}$		182		pF
Reverse Transfer Capacitance	C_{rss}	$V_{GS} = 0\text{V}, V_{DS} = 325\text{V}, f = 1\text{MHz}$		10.0		pF
Gate Resistance	R_g	$f = 1\text{MHz}$		9.3		Ω
SWITCHING PARAMETERS ⁽⁵⁾						
Total Gate Charge (@ $V_{GS} = 10\text{V}$)	Q_g	$V_{GS} = 0 \text{ to } 10\text{V}$ $V_{DS} = 325\text{V}, I_D = 7.5\text{A}$		22		nC
Gate Source Charge	Q_{gs}			7.8		nC
Gate Drain Charge	Q_{gd}			7.2		nC
Turn-On DelayTime	$t_{D(on)}$	$V_{GS} = 10\text{V}, V_{DS} = 325\text{V}$ $R_L = 43\Omega, R_{GEN} = 6\Omega$		15.4		ns
Turn-On Rise Time	t_r			12.0		ns
Turn-Off DelayTime	$t_{D(off)}$			58		ns
Turn-Off Fall Time	t_f			55		ns
Body Diode Reverse Recovery Time	t_{rr}	$I_F = 7.5\text{A}, di/dt = 100\text{A}/\mu\text{s}$		280		ns
Body Diode Reverse Recovery Charge	Q_{rr}	$I_F = 7.5\text{A}, di/dt = 100\text{A}/\mu\text{s}$		3.42		μC
Peak Diode Recovery Voltage Slope	dv/dt	$I_F \leq 8\text{A}, di/dt = 200\text{A}/\mu\text{s}, V_{DS} = 400\text{V}$		15		V/ns
MOSFET dv/dt Ruggedness	dv/dt	$V_{DS} = 0\dots 400\text{V}$		50		V/ns

Thermal Performance

Parameter	Symbol	Typ.	Max.	Unit
Thermal Resistance, Junction-to-Ambient	$R_{\theta JA}$	55	68	$^\circ\text{C}/\text{W}$
Thermal Resistance, Junction-to-Case	$R_{\theta JC}$	3.5	4.0	$^\circ\text{C}/\text{W}$

Notes:

1. Computed continuous current assumes the condition of T_{J_Max} while the actual continuous current depends on the thermal & electro-mechanical application board design.
2. This single-pulse measurement was taken under $T_{J_Max} = 150^\circ\text{C}$.
3. This single-pulse measurement was taken under the following condition [$L = 10\text{mH}, V_{GS} = 10\text{V}, V_{DS} = 50\text{V}$] while its value is limited by $T_{J_Max} = 150^\circ\text{C}$.
4. The power dissipation P_D is based on $T_{J_Max} = 150^\circ\text{C}$.
5. This value is guaranteed by design hence it is not included in the production test.

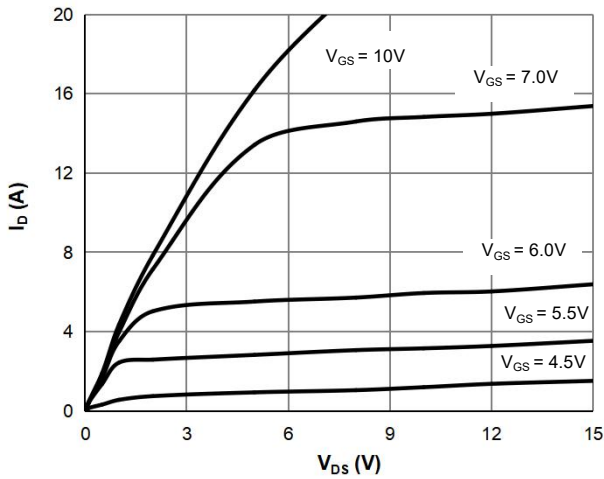
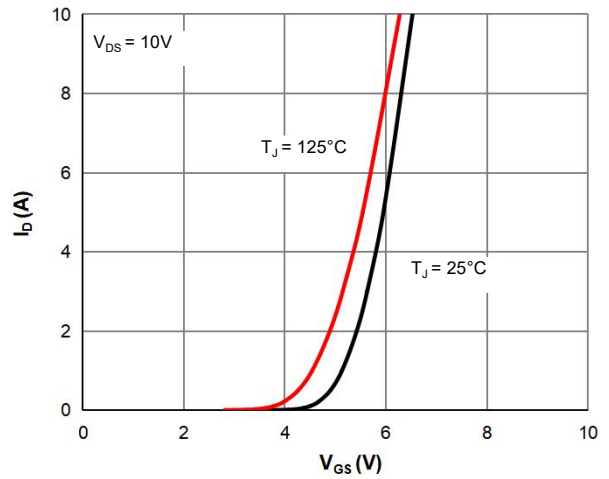
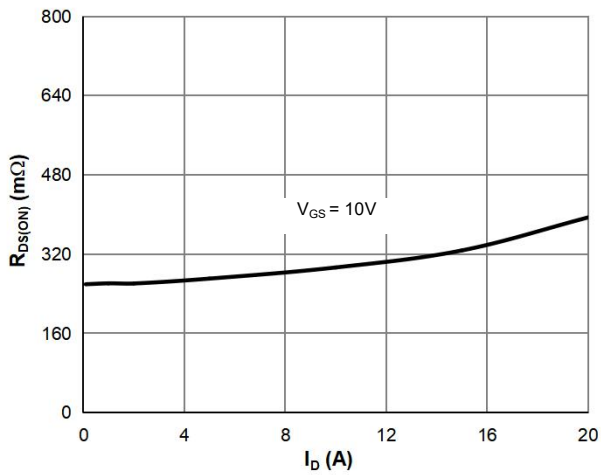
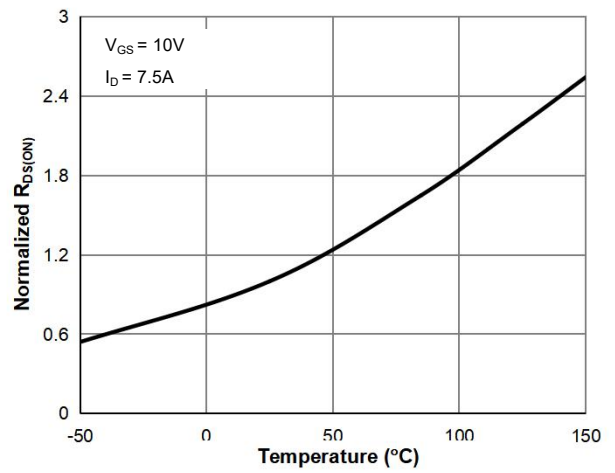
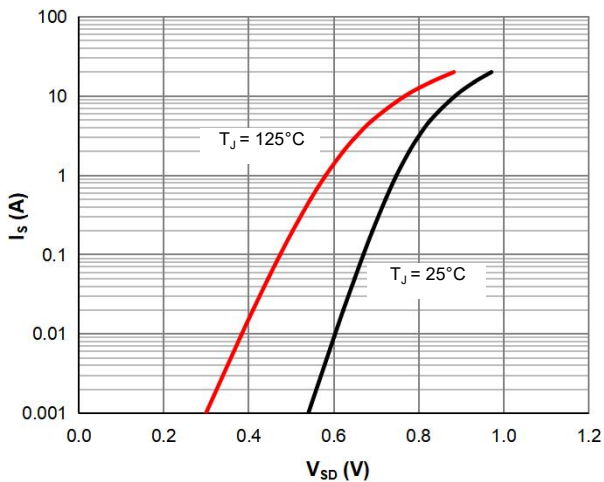
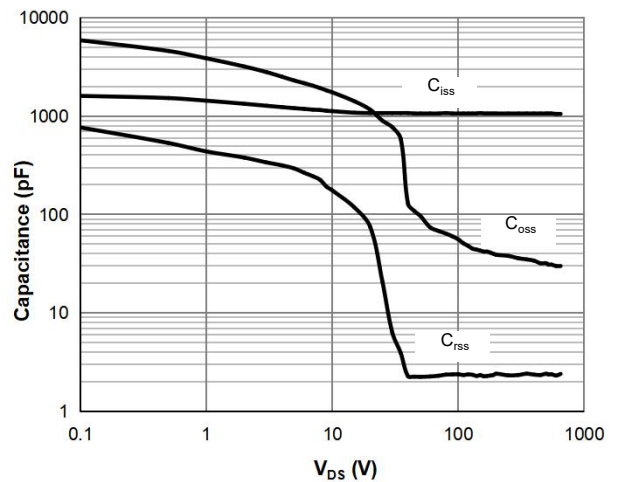
Typical Electrical & Thermal Characteristics

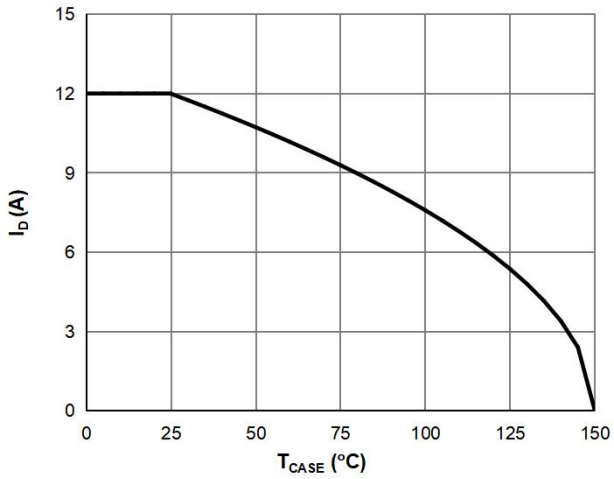
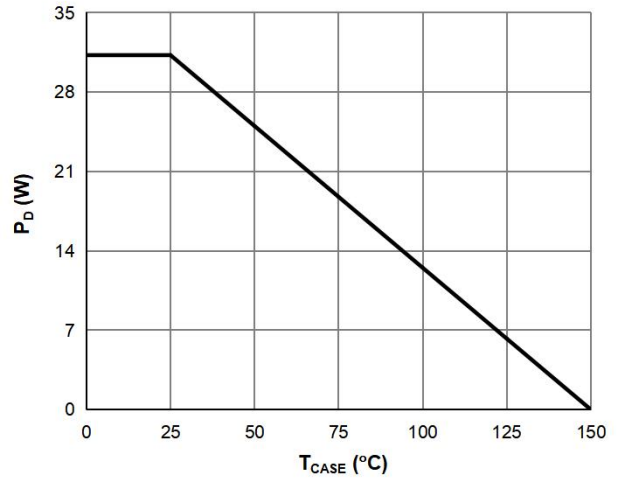
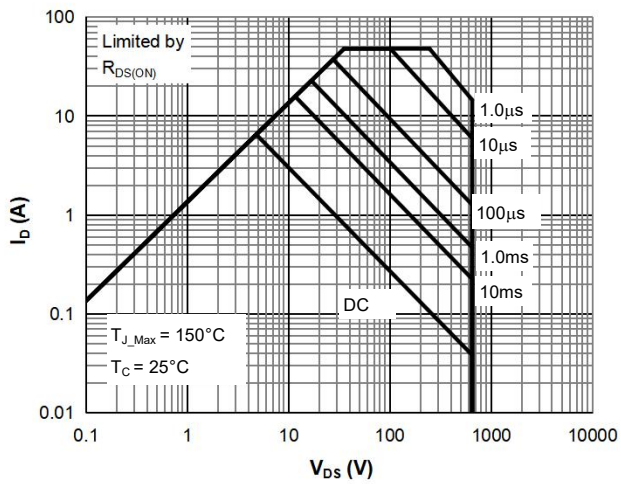
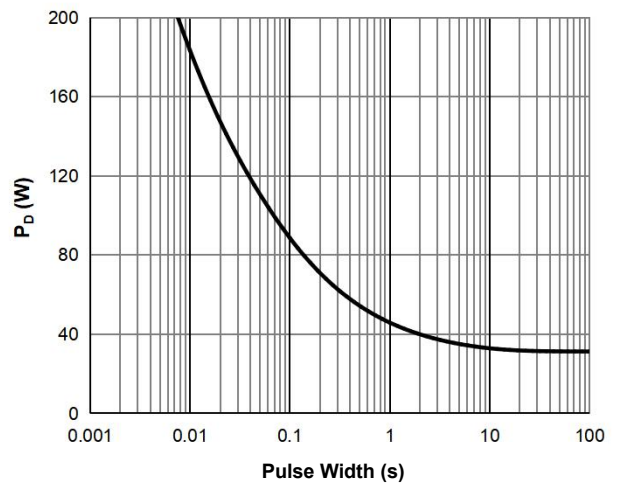
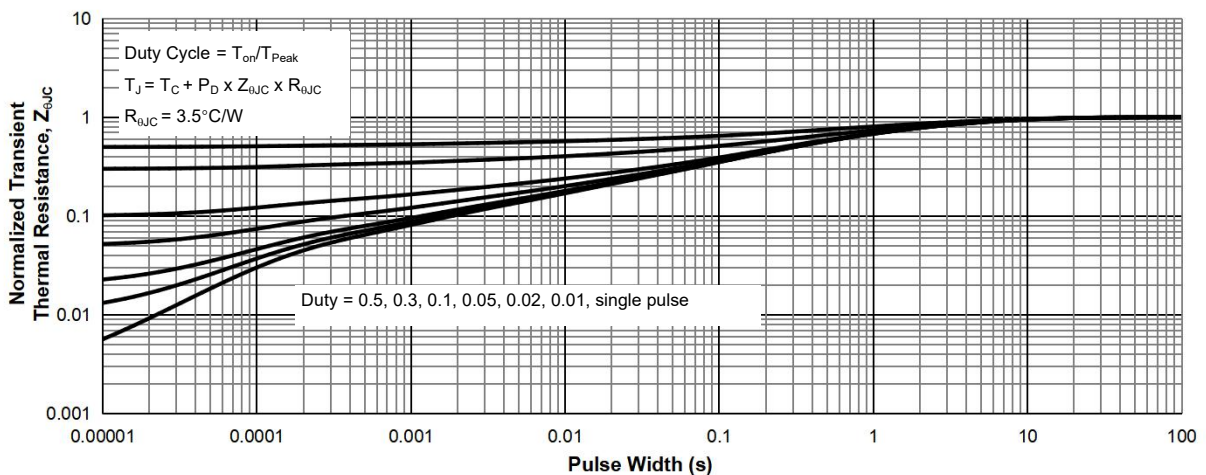
Figure 1: Saturation Characteristics

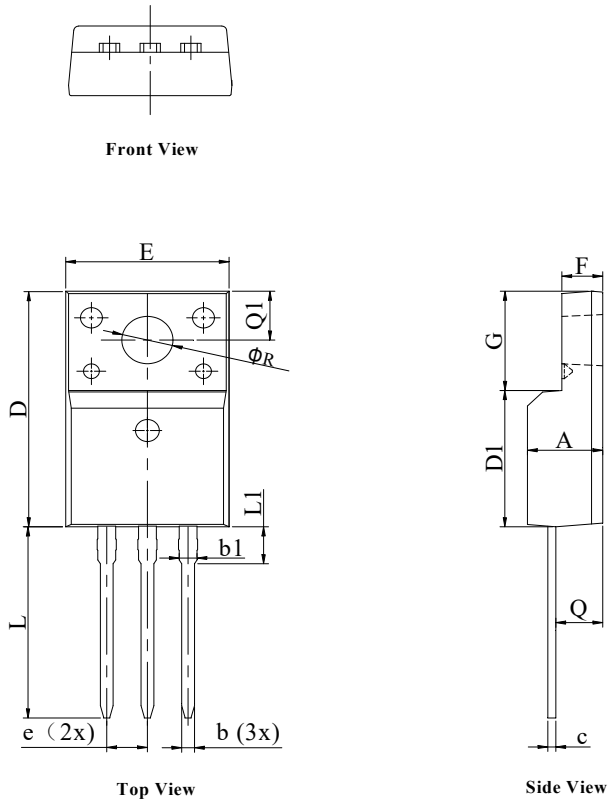
Figure 2: Transfer Characteristics

Figure 3: $R_{DS(ON)}$ vs. Drain Current

Figure 4: $R_{DS(ON)}$ vs. Junction Temperature

Figure 5: Body-Diode Characteristics

Figure 6: Capacitance Characteristics

Typical Electrical & Thermal Characteristics

Figure 7: Current De-rating

Figure 8: Power De-rating

Figure 9: Maximum Safe Operating Area

Figure 10: Single Pulse Power Rating, Junction-to-Case

Figure 11: Normalized Maximum Transient Thermal Impedance

TO-220FP-3L Package Information
Package Outline

DIM.	MILLIMETER		
	MIN.	NOM.	MAX.
A	4.50	4.70	4.90
D	15.20	15.87	16.10
D1	8.80	--	9.50
E	9.70	10.10	10.40
F	2.44	--	2.75
b	0.70	0.80	0.91
b1	1.10	1.35	1.55
c	0.45	0.50	0.65
e	2.54 BSC		
G	6.40	6.70	6.90
L	12.00	13.10	14.50
L1	3.13	--	3.57
Q	2.60	2.75	2.85
Q1	3.20	3.30	3.40
R	3.05	--	3.28