



150V 14.0mΩ N-Ch Power MOSFET

Features

- Low ON-resistance, $R_{DS(ON)}$
- Low Gate Charge, Q_g
- 100% UIS and R_g Tested
- Pb-free Lead Plating
- Halogen-free and RoHS-compliant
- AEC-Q101 Qualified for Automotive Applications

Product Summary

Parameter	Value	Unit
V_{DS}	150	V
$V_{GS(th_Typ)}$	3.2	V
I_D (@ $V_{GS} = 10V$) ⁽¹⁾	71	A
$R_{DS(ON_Typ)}$ (@ $V_{GS} = 10V$)	14.0	mΩ

TO-263-3L Top View

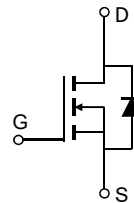
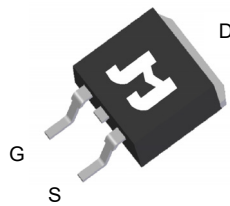

Ordering Information

Device	Package	# of Pins	Marking	MSL	T_J (°C)	Media	Quantity (pcs)
JMSH1516AEQ-13	TO-263-3L	3	SH1516AQ	1	-55 to 175	13-inch Reel	800

Absolute Maximum Ratings (@ $T_A = 25^\circ C$ unless otherwise specified)

Parameter	Symbol	Value	Unit
Drain-to-Source Voltage	V_{DS}	150	V
Gate-to-Source Voltage	V_{GS}	±20	V
Continuous Drain Current ⁽¹⁾	I_D	$T_C = 25^\circ C$	71
		$T_C = 100^\circ C$	50
Pulsed Drain Current ⁽²⁾	I_{DM}	284	A
Avalanche Energy ⁽³⁾	E_{AS}	192	mJ
Power Dissipation ⁽⁴⁾	P_D	$T_C = 25^\circ C$	214
		$T_C = 100^\circ C$	107
Junction & Storage Temperature Range	T_J, T_{STG}	-55 to 175	°C

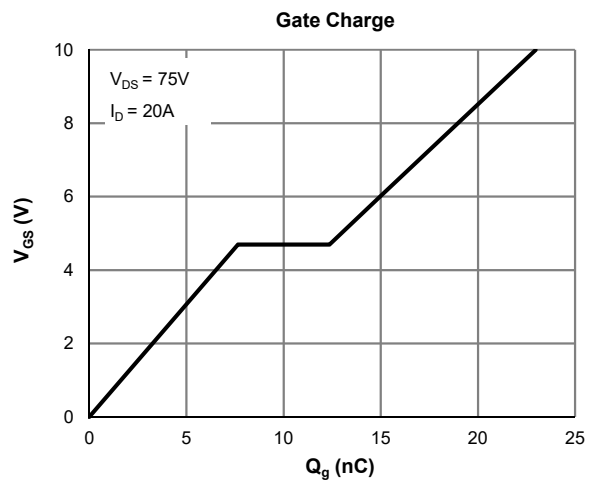
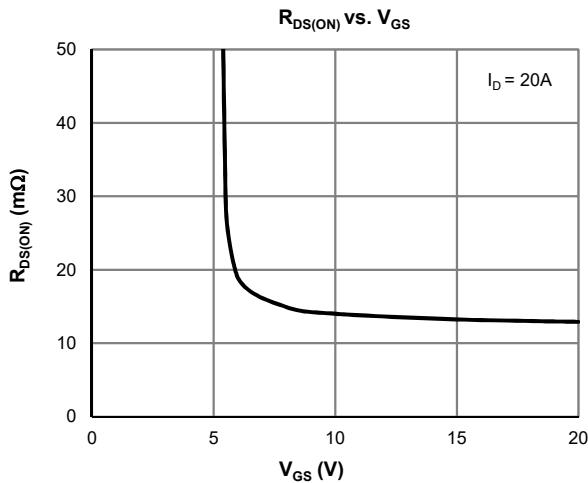

**Electrical Characteristics** (@ $T_J = 25^\circ\text{C}$ unless otherwise specified)

Parameter	Symbol	Conditions	Min.	Typ.	Max.	Unit
STATIC PARAMETERS						
Drain-Source Breakdown Voltage	$V_{(BR)DSS}$	$I_D = 250\mu\text{A}, V_{GS} = 0\text{V}$	150			V
Zero Gate Voltage Drain Current	I_{DSS}	$V_{DS} = 120\text{V}, V_{GS} = 0\text{V}$			1.0	μA
					5.0	
Gate-Body Leakage Current	I_{GSS}	$V_{DS} = 0\text{V}, V_{GS} = \pm 20\text{V}$			± 100	nA
Gate Threshold Voltage	$V_{GS(th)}$	$V_{DS} = V_{GS}, I_D = 250\mu\text{A}$	2.5	3.2	4.5	V
Static Drain-Source ON-Resistance	$R_{DS(ON)}$	$V_{GS} = 10\text{V}, I_D = 20\text{A}$		14.0	16.8	$\text{m}\Omega$
Forward Transconductance	g_{FS}	$V_{DS} = 5\text{V}, I_D = 20\text{A}$		58		S
Diode Forward Voltage	V_{SD}	$I_S = 1\text{A}, V_{GS} = 0\text{V}$		0.68	1.0	V
Diode Continuous Current	I_S	$T_C = 25^\circ\text{C}$			214	A

DYNAMIC PARAMETERS ⁽⁵⁾

Input Capacitance	C_{iss}	$V_{GS} = 0\text{V}, V_{DS} = 75\text{V}, f = 1\text{MHz}$		1603		pF
Output Capacitance	C_{oss}			196		pF
Reverse Transfer Capacitance	C_{rss}			7.5		pF
Gate Resistance	R_g	$V_{GS} = 0\text{V}, V_{DS} = 0\text{V}, f = 1\text{MHz}$		1.8		Ω

SWITCHING PARAMETERS ⁽⁵⁾

Total Gate Charge (@ $V_{GS} = 10\text{V}$)	Q_g	$V_{GS} = 0 \text{ to } 10\text{V}$ $V_{DS} = 75\text{V}, I_D = 20\text{A}$		23		nC
Total Gate Charge (@ $V_{GS} = 6.0\text{V}$)	Q_g			15		nC
Gate Source Charge	Q_{gs}			7.7		nC
Gate Drain Charge	Q_{gd}			4.7		nC
Turn-On DelayTime	$t_{D(on)}$	$V_{GS} = 10\text{V}, V_{DS} = 75\text{V}$ $R_L = 3.8\Omega, R_{GEN} = 6\Omega$		7.1		ns
Turn-On Rise Time	t_r			8.4		ns
Turn-Off DelayTime	$t_{D(off)}$			16.7		ns
Turn-Off Fall Time	t_f			10.9		ns
Body Diode Reverse Recovery Time	t_{rr}		$I_F = 20\text{A}, dI_F/dt = 100\text{A}/\mu\text{s}$		86	
Body Diode Reverse Recovery Charge	Q_{rr}	$I_F = 20\text{A}, dI_F/dt = 100\text{A}/\mu\text{s}$		137		nC

Thermal Performance

Parameter	Symbol	Typ.	Max.	Unit
Thermal Resistance, Junction-to-Ambient	$R_{\theta JA}$	45	55	$^\circ\text{C}/\text{W}$
Thermal Resistance, Junction-to-Case	$R_{\theta JC}$	0.70	0.90	$^\circ\text{C}/\text{W}$

Notes:

1. Computed continuous current assumes the condition of T_{J_Max} while the actual continuous current depends on the thermal & electro-mechanical application board design.
2. This single-pulse measurement was taken under $T_{J_Max} = 175^\circ\text{C}$.
3. E_{AS} of 192 mJ is based on starting $T_J = 25^\circ\text{C}$, $L = 1.0\text{mH}$, $I_{AS} = 19.6\text{A}$, $V_{GS} = 10\text{V}$, $V_{DD} = 75\text{V}$; 100% test at $L = 0.3\text{mH}$, $I_{AS} = 30\text{A}$.
 $T_{J_Max} = 175^\circ\text{C}$.
4. The power dissipation P_D is based on $T_{J_Max} = 175^\circ\text{C}$.
5. This value is guaranteed by design hence it is not included in the production test.

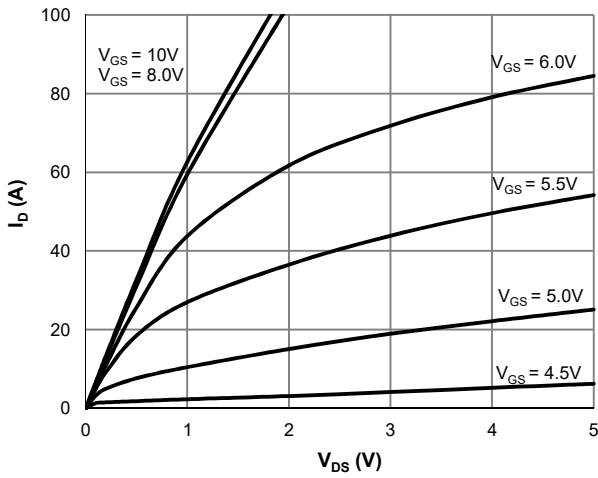
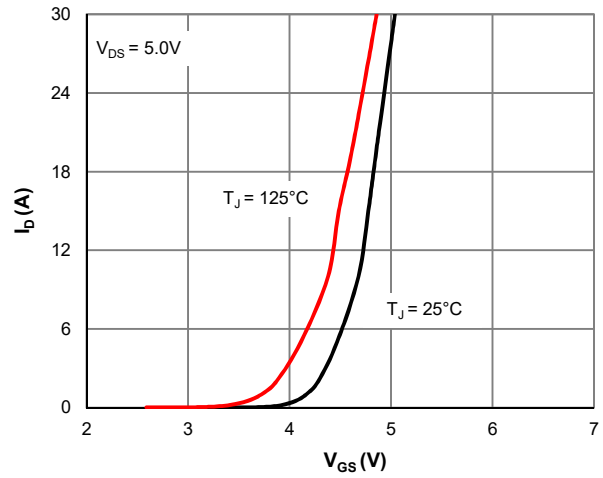
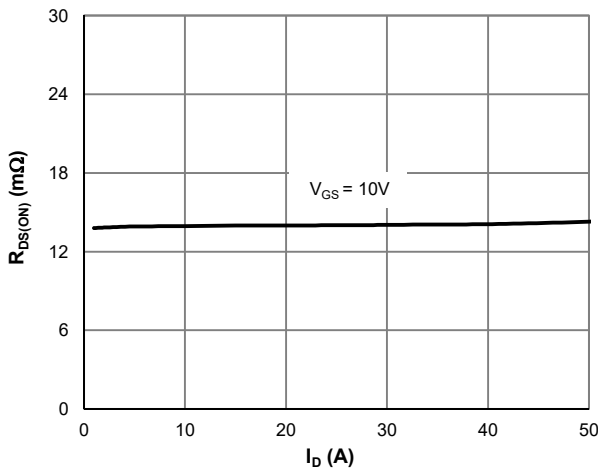
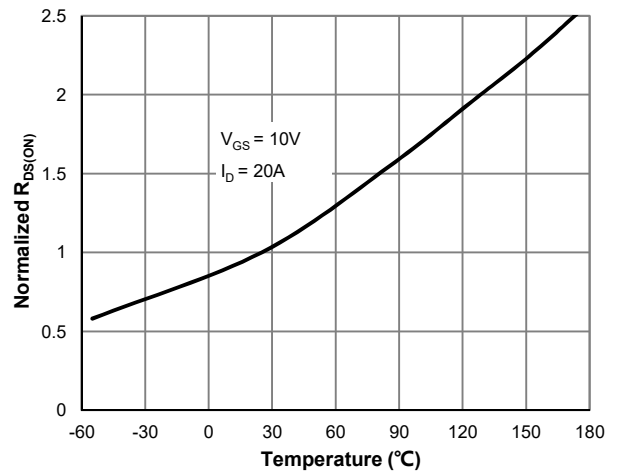
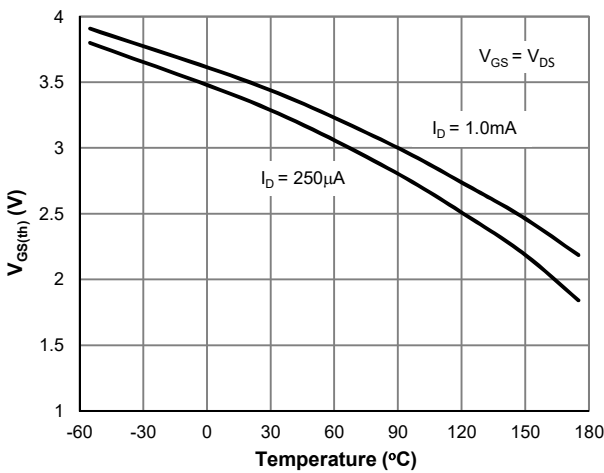
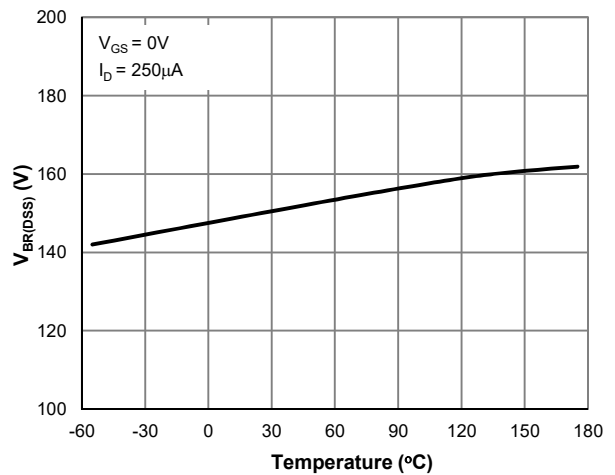
Typical Electrical & Thermal Characteristics

Figure 1: Saturation Characteristics

Figure 2: Transfer Characteristics

Figure 3: $R_{DS(ON)}$ vs. Drain Current

Figure 4: $R_{DS(ON)}$ vs. Junction Temperature

Figure 5: $V_{GS(th)}$ vs. Junction Temperature

Figure 6: $V_{BR(DSS)}$ vs. Junction Temperature

Typical Electrical & Thermal Characteristics

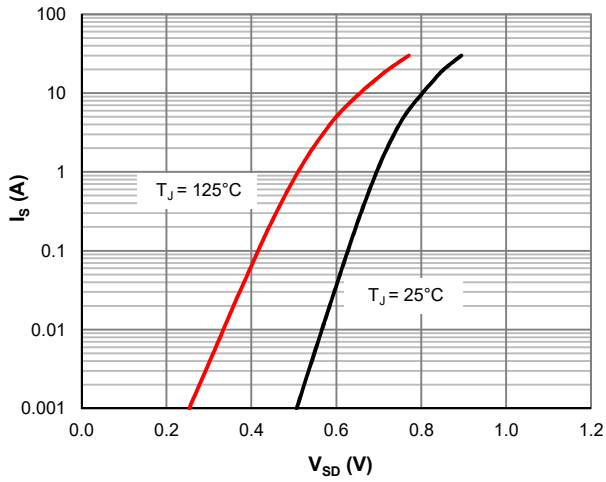

Figure 7: Body-Diode Characteristics

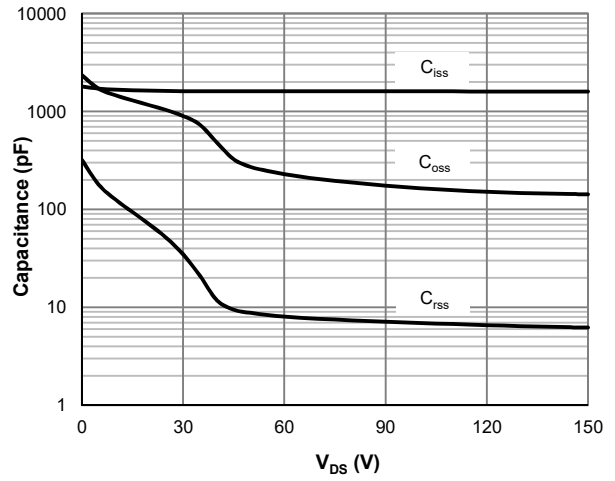

Figure 8: Capacitance Characteristics

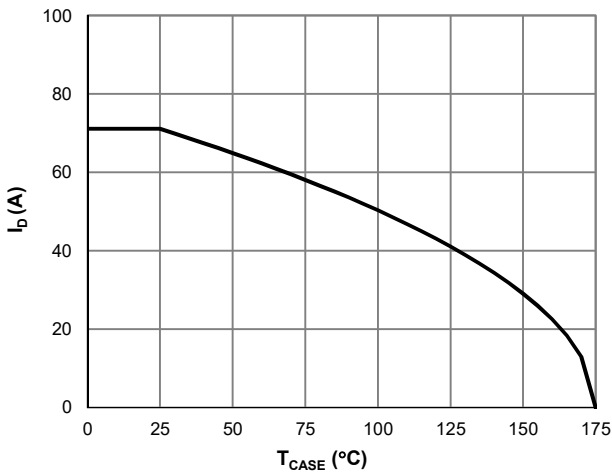

Figure 9: Current De-rating

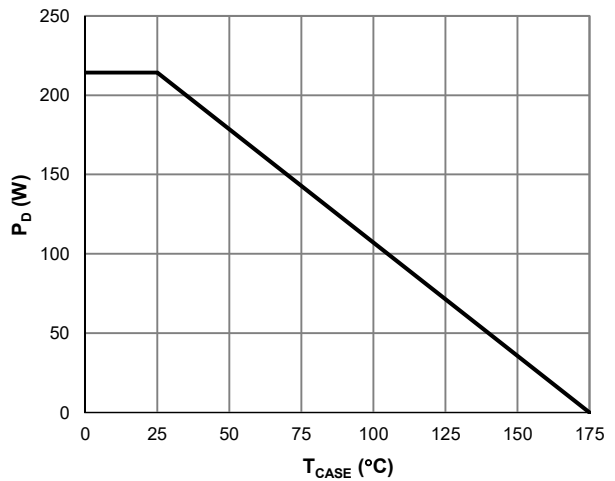

Figure 10: Power De-rating

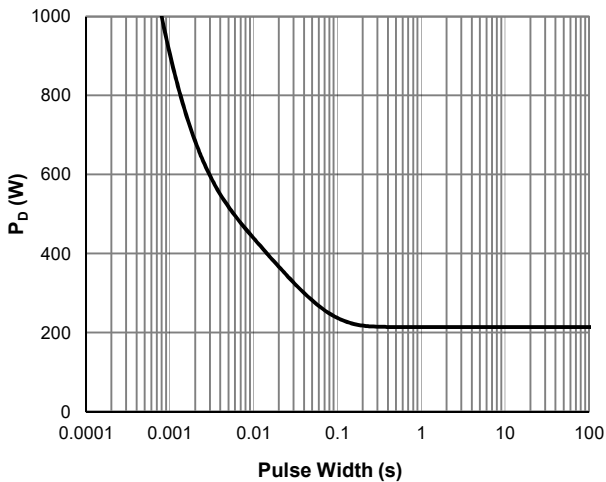

Figure 11: Single Pulse Power Rating, Junction-to-Case

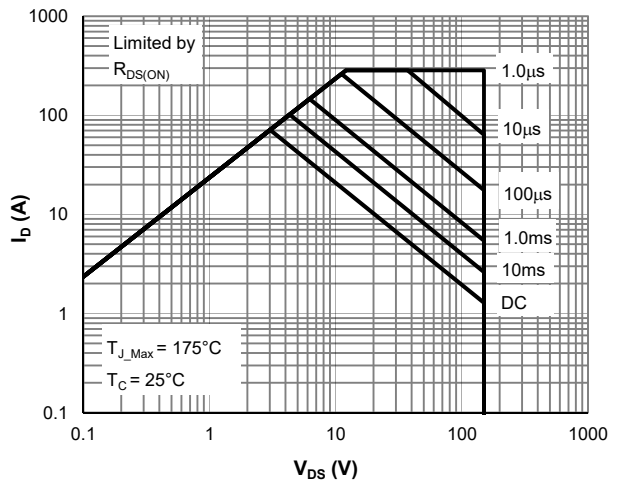

Figure 12: Maximum Safe Operating Area



Typical Electrical & Thermal Characteristics

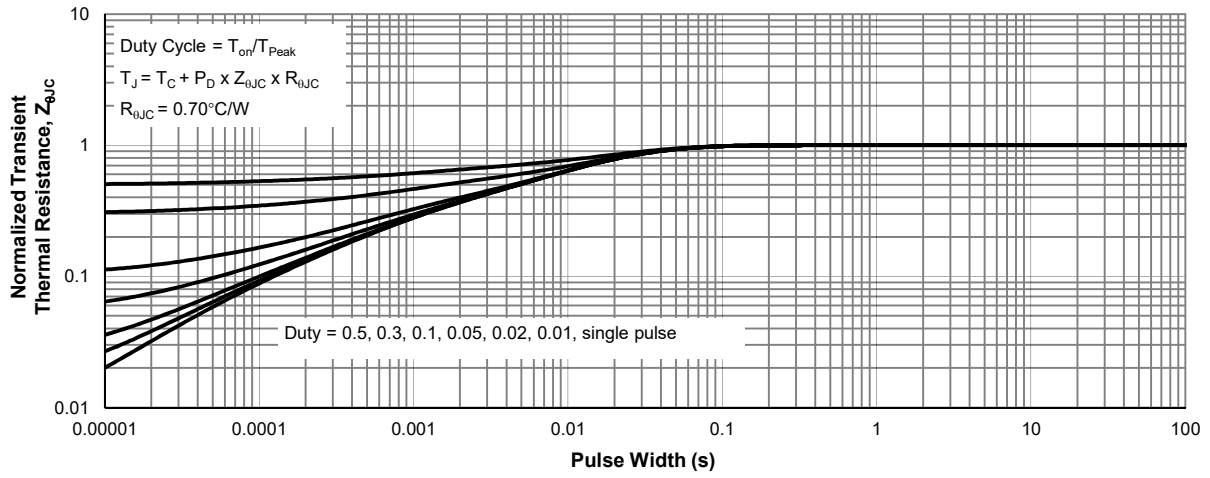
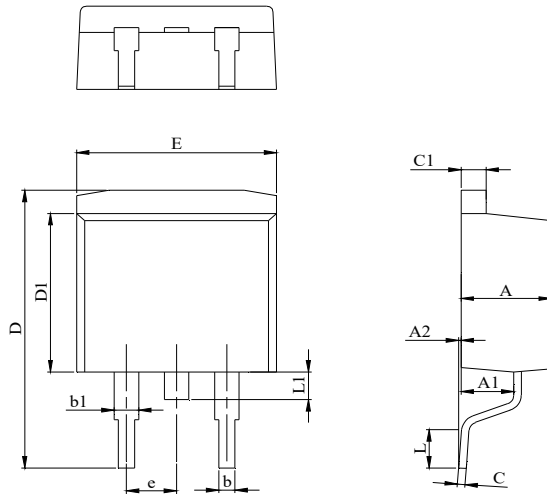

Figure 13: Normalized Maximum Transient Thermal Impedance

TO-263-3L Package Information
Package Outline

DIM.	MILLIMETER		
	MIN.	NOM.	MAX.
A	4.24		4.77
A1	2.30		2.89
A2	0.00	0.10	0.25
b	0.70		0.96
b1	1.17		1.70
C	0.30		0.60
C1	1.15		1.42
D	14.10		15.88
D1	8.50		9.60
E	9.78		10.36
L	1.78		2.79
L1			1.75
e		2.54	

Recommend Soldering Footprint
