

60V 4.6mΩ N-Ch Power MOSFET

Features

- Ultra-low $R_{DS(ON)}$
- Low Gate Charge
- 100% UIS Tested, 100% R_g Tested
- Pb-free Lead Plating
- Halogen-free and RoHS-compliant

Product Summary

Parameter	Typ.	Unit
V_{DS}	60	V
$V_{GS(th)}$	1.7	V
I_D (@ $V_{GS} = 10V$) ⁽¹⁾	90	A
$R_{DS(ON)}$ (@ $V_{GS} = 10V$)	4.6	mΩ
$R_{DS(ON)}$ (@ $V_{GS} = 4.5V$)	6.0	mΩ

Applications

- Power Management in Computing, CE, IE 4.0, Communications
- Current Switching in DC/DC & AC/DC (SR) Sub-systems
- Load Switching, Quick/Wireless Charging, Motor Driving

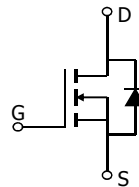
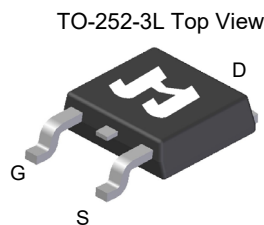

Ordering Information

Device	Package	# of Pins	Marking	MSL	T_J (°C)	Media	Quantity (pcs)
JMSL0606AK-13	TO-252-3L	3	SL0606A	1	-55 to 150	13-inch Reel	2500

Absolute Maximum Ratings (@ $T_A = 25^\circ\text{C}$ unless otherwise specified)

Parameter	Symbol	Value	Unit
Drain-to-Source Voltage	V_{DS}	60	V
Gate-to-Source Voltage	V_{GS}	±20	V
Continuous Drain Current ⁽¹⁾	I_D	$T_C = 25^\circ\text{C}$	90
		$T_C = 100^\circ\text{C}$	57
Pulsed Drain Current ⁽²⁾	I_{DM}	269	A
Avalanche Current ⁽³⁾	I_{AS}	32	A
Avalanche Energy ⁽³⁾	E_{AS}	51	mJ
Power Dissipation ⁽⁴⁾	P_D	$T_C = 25^\circ\text{C}$	83
		$T_C = 100^\circ\text{C}$	33
Junction & Storage Temperature Range	T_J, T_{STG}	-55 to 150	°C

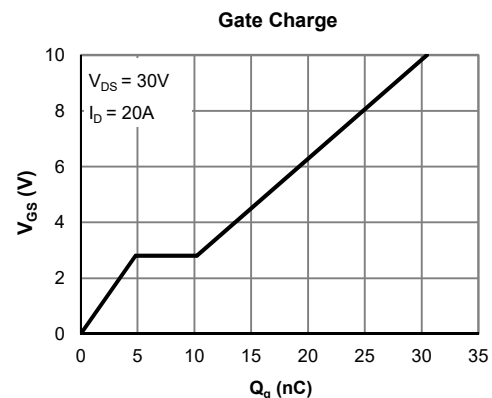
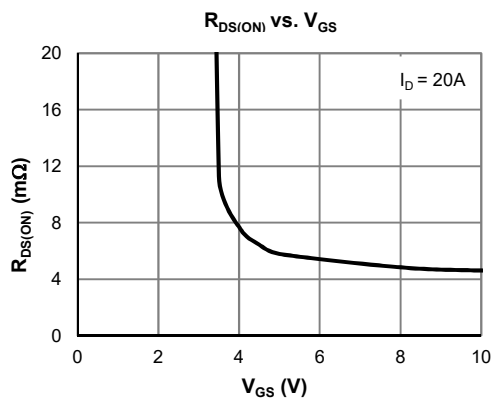

**Electrical Characteristics** (@ $T_J = 25^\circ\text{C}$ unless otherwise specified)

Parameter	Symbol	Conditions	Min.	Typ.	Max.	Unit
STATIC PARAMETERS						
Drain-Source Breakdown Voltage	$V_{(BR)DSS}$	$I_D = 250\mu\text{A}$, $V_{GS} = 0\text{V}$	60			V
Zero Gate Voltage Drain Current	I_{DSS}	$V_{DS} = 48\text{V}$, $V_{GS} = 0\text{V}$ $T_J = 55^\circ\text{C}$			1.0 5.0	μA
Gate-Body Leakage Current	I_{GSS}	$V_{DS} = 0\text{V}$, $V_{GS} = \pm 20\text{V}$			± 100	nA
Gate Threshold Voltage	$V_{GS(th)}$	$V_{DS} = V_{GS}$, $I_D = 250\mu\text{A}$	1.2	1.7	2.5	V
Static Drain-Source ON-Resistance	$R_{DS(on)}$	$V_{GS} = 10\text{V}$, $I_D = 20\text{A}$		4.6	5.8	m Ω
		$V_{GS} = 4.5\text{V}$, $I_D = 15\text{A}$		6.0	7.5	m Ω
Forward Transconductance	g_{FS}	$V_{DS} = 5\text{V}$, $I_D = 20\text{A}$		85		S
Diode Forward Voltage	V_{SD}	$I_S = 1\text{A}$, $V_{GS} = 0\text{V}$		0.7	1.0	V
Diode Continuous Current	I_S	$T_C = 25^\circ\text{C}$			83	A
DYNAMIC PARAMETERS ⁽⁵⁾						
Input Capacitance	C_{iss}	$V_{GS} = 0\text{V}$, $V_{DS} = 30\text{V}$, $f = 1\text{MHz}$		2122		pF
Output Capacitance	C_{oss}			440		pF
Reverse Transfer Capacitance	C_{rss}			4.4		pF
Gate Resistance	R_g	$V_{GS} = 0\text{V}$, $V_{DS} = 0\text{V}$, $f = 1\text{MHz}$		1.4		Ω
SWITCHING PARAMETERS ⁽⁵⁾						
Total Gate Charge (@ $V_{GS} = 10\text{V}$)	Q_g	$V_{GS} = 0$ to 10V $V_{DS} = 30\text{V}$, $I_D = 20\text{A}$		31		nC
Total Gate Charge (@ $V_{GS} = 4.5\text{V}$)	Q_g			14		nC
Gate Source Charge	Q_{gs}			4.8		nC
Gate Drain Charge	Q_{gd}			5.4		nC
Turn-On Delay Time	$t_{D(on)}$	$V_{GS} = 10\text{V}$, $V_{DS} = 30\text{V}$ $R_L = 1.5\Omega$, $R_{GEN} = 6\Omega$		8.0		ns
Turn-On Rise Time	t_r			5.1		ns
Turn-Off Delay Time	$t_{D(off)}$			38		ns
Turn-Off Fall Time	t_f			14.8		ns
Body Diode Reverse Recovery Time	t_{rr}		$I_F = 20\text{A}$, $dI_F/dt = 100\text{A}/\mu\text{s}$		37	
Body Diode Reverse Recovery Charge	Q_{rr}	$I_F = 20\text{A}$, $dI_F/dt = 100\text{A}/\mu\text{s}$		43		nC

Thermal Performance

Parameter	Symbol	Typ.	Max.	Unit
Thermal Resistance, Junction-to-Ambient	$R_{\theta JA}$	45	55	$^\circ\text{C}/\text{W}$
Thermal Resistance, Junction-to-Case	$R_{\theta JC}$	1.2	1.5	$^\circ\text{C}/\text{W}$

Notes:

1. Computed continuous current assumes the condition of T_{J_Max} while the actual continuous current depends on the thermal & electro-mechanical application board design.
2. This single-pulse measurement was taken under $T_{J_Max} = 150^\circ\text{C}$.
3. This single-pulse measurement was taken under the following condition [$L = 100\mu\text{H}$, $V_{GS} = 10\text{V}$, $V_{DD} = 30\text{V}$] while its value is limited by $T_{J_Max} = 150^\circ\text{C}$.
4. The power dissipation P_D is based on $T_{J_Max} = 150^\circ\text{C}$.
5. This value is guaranteed by design hence it is not included in the production test.

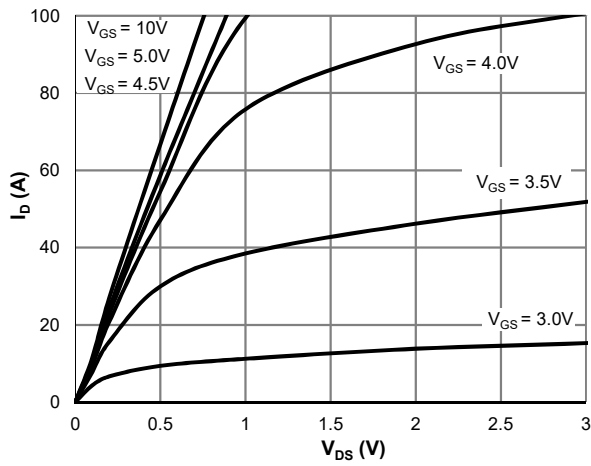
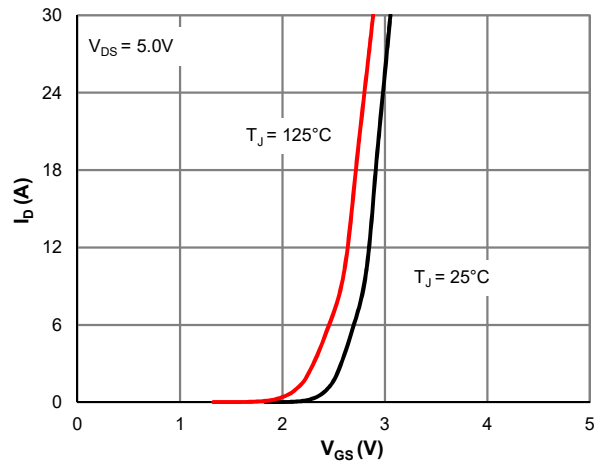
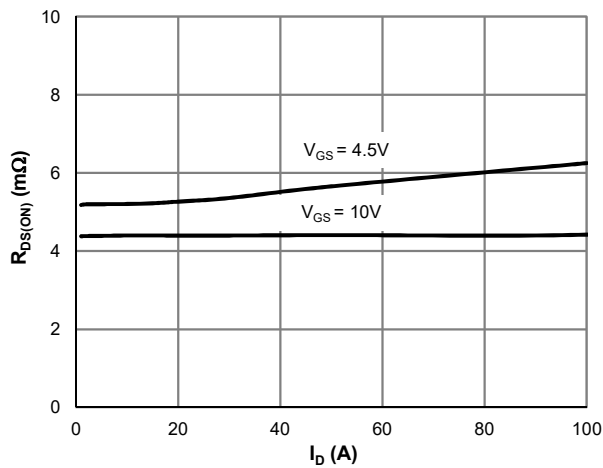
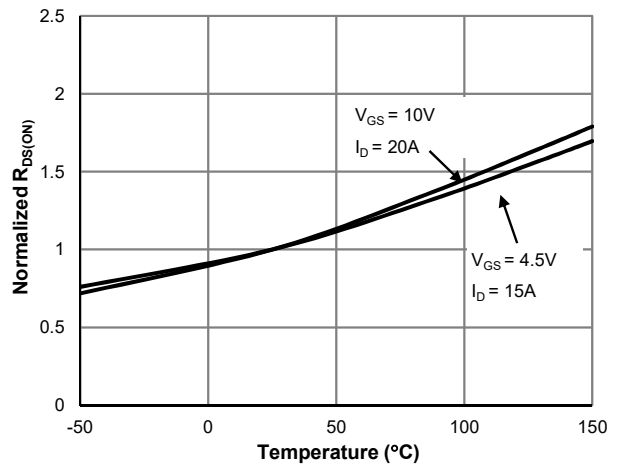
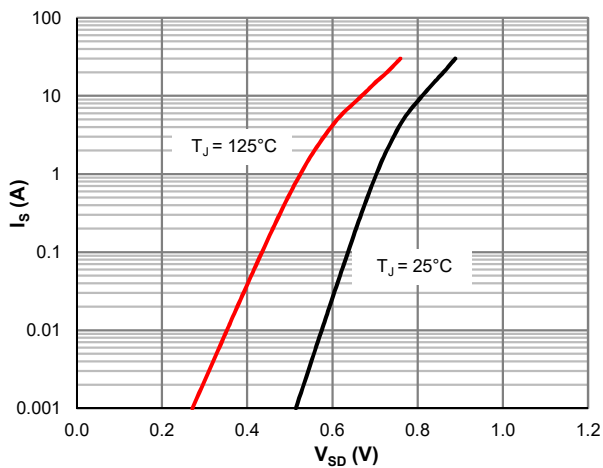
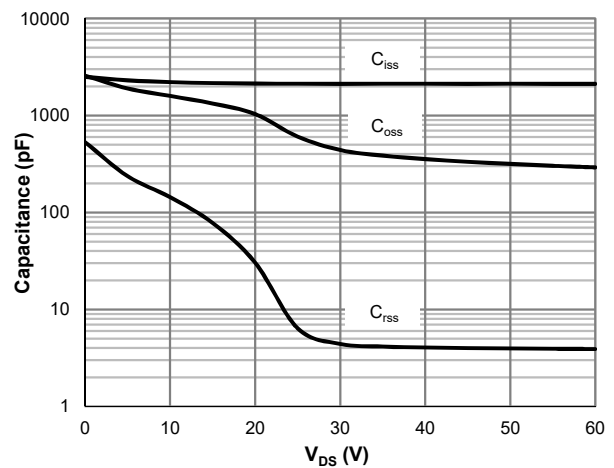
Typical Electrical & Thermal Characteristics

Figure 1: Saturation Characteristics

Figure 2: Transfer Characteristics

Figure 3: $R_{DS(ON)}$ vs. Drain Current

Figure 4: $R_{DS(ON)}$ vs. Junction Temperature

Figure 5: Body-Diode Characteristics

Figure 6: Capacitance Characteristics

Typical Electrical & Thermal Characteristics

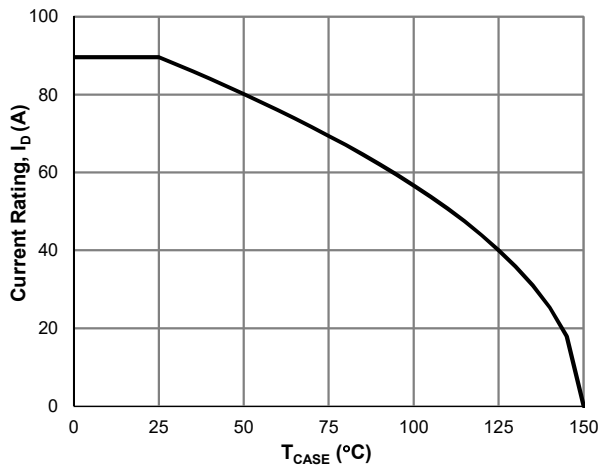

Figure 7: Current De-rating

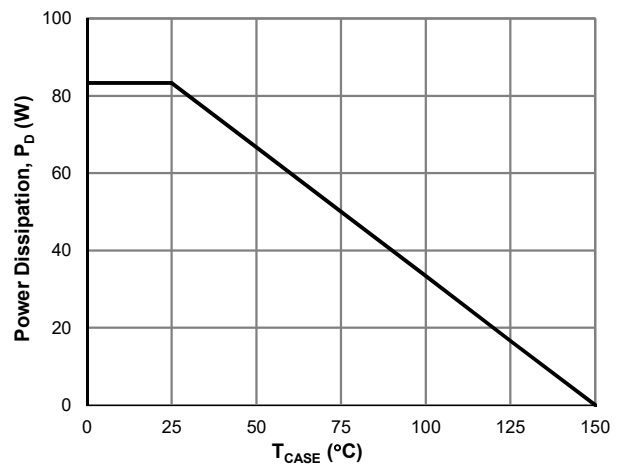

Figure 8: Power De-rating

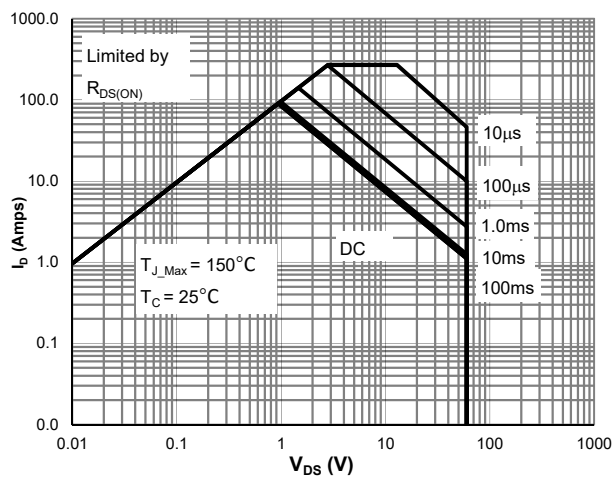

Figure 9: Maximum Safe Operating Area

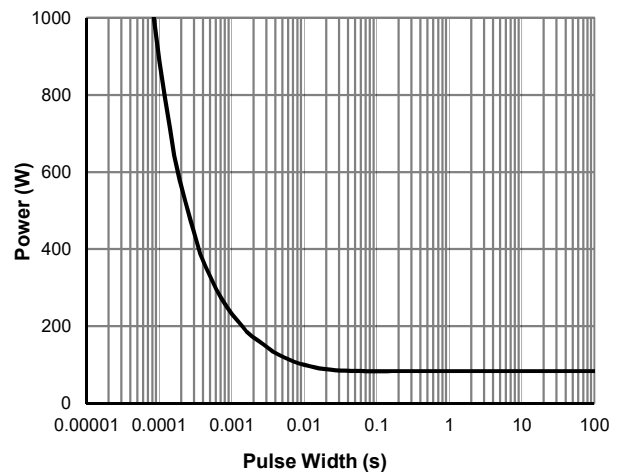

Figure 10: Single Pulse Power Rating, Junction-to-Case

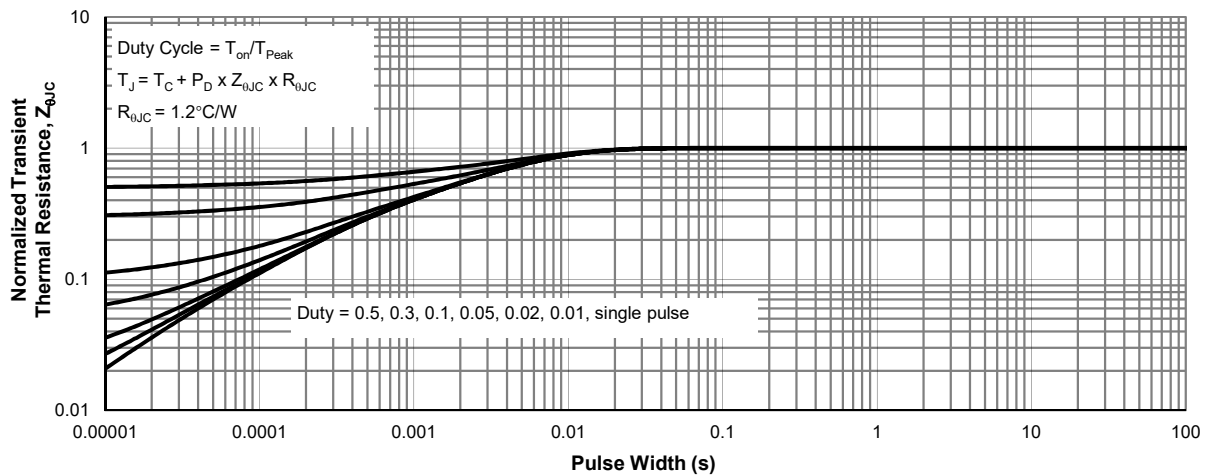
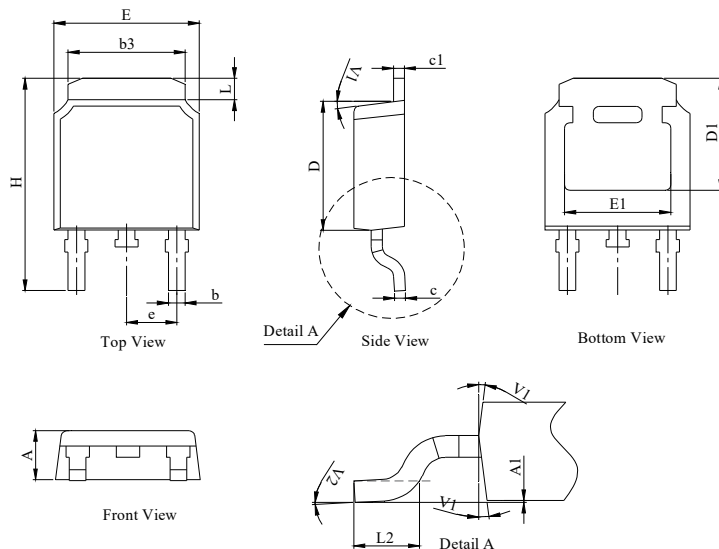
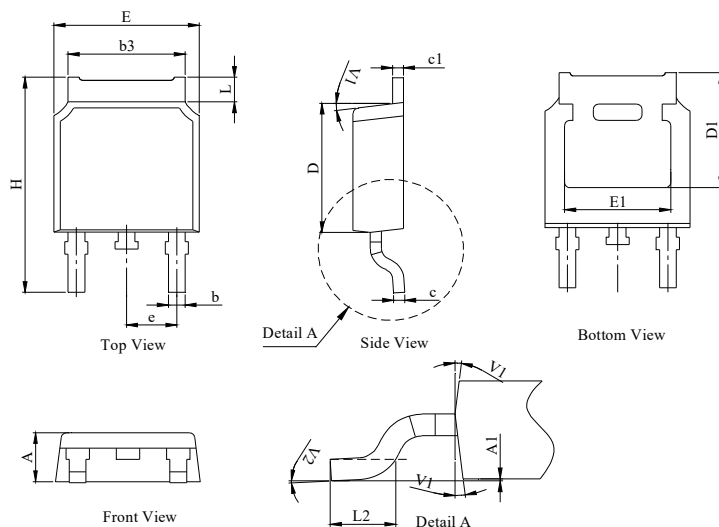

Figure 11: Normalized Maximum Transient Thermal Impedance

TO-252-3L Package Information
Package Outline Type-A

DIM.	MILLIMETER		
	MIN.	NOM.	MAX.
A	2.18	2.30	2.39
A1	0	--	0.13
b	0.64	0.76	0.89
c	0.40	0.50	0.61
c1	0.46	0.50	0.58
D	5.97	6.10	6.23
D1	5.05	--	--
E	6.35	6.60	6.73
E1	4.32	--	--
b3	5.21	5.38	5.55
e	2.29 BSC		
H	9.40	10.00	10.40
L	0.89	--	1.27
L2	1.40	--	1.78
V1	7° REF		
V2	0°	--	6°

Package Outline Type-B

DIM.	MILLIMETER		
	MIN.	NOM.	MAX.
A	2.10	2.30	2.40
A1	0	--	0.13
b	0.66	0.76	0.86
b3	5.21	5.38	5.55
c	0.40	0.50	0.60
c1	0.44	0.50	0.58
D	5.90	6.10	6.30
D1	5.30REF		
E	6.40	6.60	6.80
E1	4.63	-	-
e	2.29 BSC		
H	9.50	10.00	10.70
L	1.09	--	1.21
L2	1.35	--	1.65
V1	7° REF		
V2	0°	--	6°

Recommended Soldering Footprint
