



60V 18mΩ Dual N-Ch Power MOSFET

Features

- Low ON Resistance, $R_{DS(ON)}$
- Low Gate Charge, Q_g
- 100% UIS and R_g Tested
- ESD-enhanced Gate Pin @ HBM Class-2 of 1.1kV Typical
- Pb-free Lead Plating, Halogen-free, RoHS-compliant
- AEC-Q101 Qualified for Automotive Applications

Product Summary

Parameter	Value	Unit
V_{DS}	60	V
$V_{GS(th_Typ)}$	1.8	V
I_D (@ $V_{GS} = 10V$) ⁽¹⁾	23	A
$R_{DS(ON_Typ)}$ (@ $V_{GS} = 10V$)	18.0	mΩ
$R_{DS(ON_Typ)}$ (@ $V_{GS} = 4.5V$)	25	mΩ

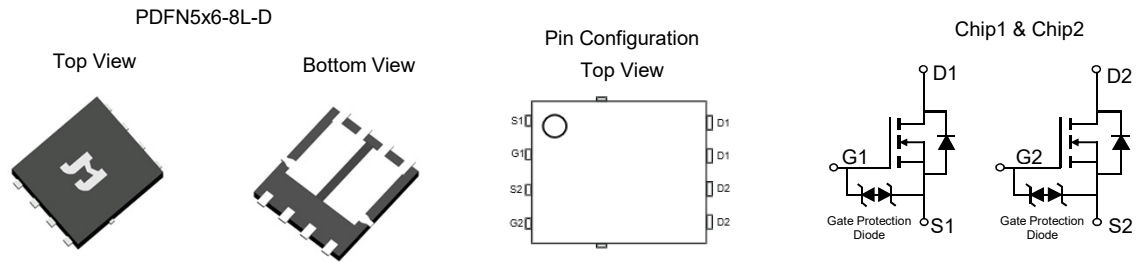

Ordering Information

Device	Package	# of Pins	Marking	MSL	T_J (°C)	Media	Quantity (pcs)
JMSL0620AGDEQ-13	PDFN5x6-8L-D	8	L0620ADQ	1	-55 to 175	13-inch Reel	5000

Absolute Maximum Ratings (@ $T_A = 25^\circ C$ unless otherwise specified)

Parameter	Symbol	Value	Unit
Drain-to-Source Voltage	V_{DS}	60	V
Gate-to-Source Voltage	V_{GS}	±20	V
Human Body Model (per JESD22-A114)	V_{ESD_GS}	1.1	kV
Continuous Drain Current ⁽¹⁾	I_D	$T_C = 25^\circ C$	23
		$T_C = 100^\circ C$	16.6
Pulsed Drain Current ⁽²⁾	I_{DM}	52	A
Avalanche Energy ⁽³⁾	E_{AS}	26	mJ
Power Dissipation ⁽⁴⁾	P_D	$T_C = 25^\circ C$	26
		$T_C = 100^\circ C$	12.9
Junction & Storage Temperature Range	T_J, T_{STG}	-55 to 175	°C

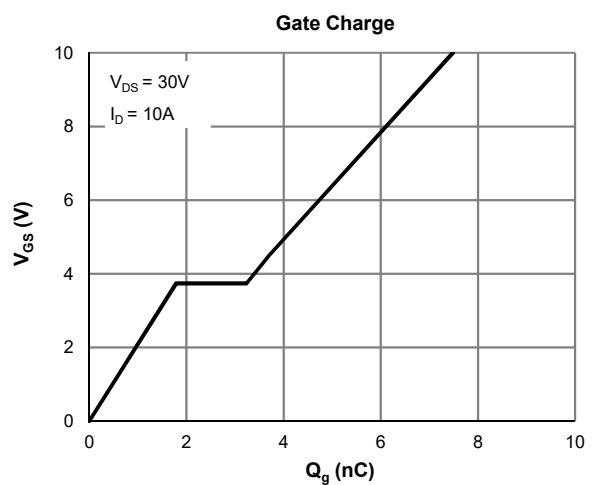
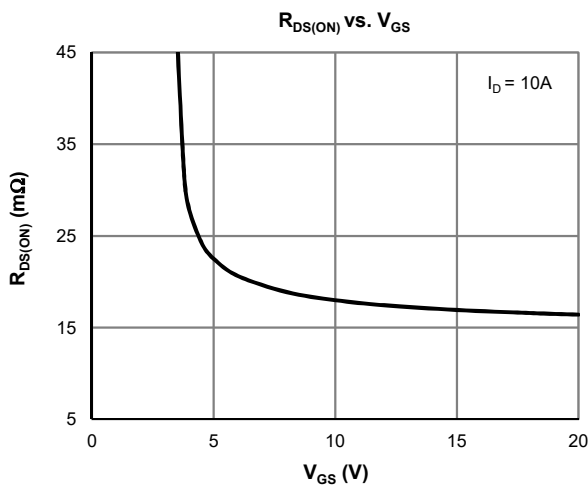



Electrical Characteristics (@ $T_J = 25^\circ\text{C}$ unless otherwise specified)

Parameter	Symbol	Conditions	Min.	Typ.	Max.	Unit
STATIC PARAMETERS						
Drain-Source Breakdown Voltage	$V_{(BR)DSS}$	$I_D = 250\mu\text{A}, V_{GS} = 0\text{V}$	60			V
Zero Gate Voltage Drain Current	I_{DSS}	$V_{DS} = 48\text{V}, V_{GS} = 0\text{V}$ $T_J = 55^\circ\text{C}$			1.0 5.0	μA
Gate-Body Leakage Current	I_{GSS}	$V_{DS} = 0\text{V}, V_{GS} = \pm 20\text{V}$			± 10	μA
Gate Threshold Voltage	$V_{GS(th)}$	$V_{DS} = V_{GS}, I_D = 250\mu\text{A}$	1.2	1.8	2.5	V
Static Drain-Source ON-Resistance	$R_{DS(ON)}$	$V_{GS} = 10\text{V}, I_D = 10\text{A}$		18.0	23	$\text{m}\Omega$
		$V_{GS} = 4.5\text{V}, I_D = 8\text{A}$		25	33	$\text{m}\Omega$
Forward Transconductance	g_{FS}	$V_{DS} = 5\text{V}, I_D = 10\text{A}$		15.5		S
Diode Forward Voltage	V_{SD}	$I_S = 1\text{A}, V_{GS} = 0\text{V}$		0.73	1.0	V
Diode Continuous Current	I_S	$T_C = 25^\circ\text{C}$			26	A

DYNAMIC PARAMETERS ⁽⁵⁾

Input Capacitance	C_{iss}	$V_{GS} = 0\text{V}, V_{DS} = 30\text{V}, f = 1\text{MHz}$		409		pF
Output Capacitance	C_{oss}			143		pF
Reverse Transfer Capacitance	C_{rss}			24		pF
Gate Resistance	R_g	$V_{GS} = 0\text{V}, V_{DS} = 0\text{V}, f = 1\text{MHz}$		3.5		Ω

SWITCHING PARAMETERS ⁽⁵⁾

Total Gate Charge (@ $V_{GS} = 10\text{V}$)	Q_g	$V_{GS} = 0 \text{ to } 10\text{V}$ $V_{DS} = 30\text{V}, I_D = 10\text{A}$		7.5		nC
Total Gate Charge (@ $V_{GS} = 4.5\text{V}$)	Q_g			3.7		nC
Gate Source Charge	Q_{gs}			1.8		nC
Gate Drain Charge	Q_{gd}			1.5		nC
Turn-On DelayTime	$t_{D(on)}$	$V_{GS} = 10\text{V}, V_{DS} = 30\text{V}$ $R_L = 3\Omega, R_{GEN} = 6\Omega$		4.4		ns
Turn-On Rise Time	t_r			23		ns
Turn-Off DelayTime	$t_{D(off)}$			11.5		ns
Turn-Off Fall Time	t_f			3.2		ns
Body Diode Reverse Recovery Time	t_{rr}	$I_F = 10\text{A}, dI_F/dt = 100\text{A}/\mu\text{s}$		15.2		ns
Body Diode Reverse Recovery Charge	Q_{rr}	$I_F = 10\text{A}, dI_F/dt = 100\text{A}/\mu\text{s}$		5.4		nC

Thermal Performance

Parameter	Symbol	Typ.	Max.	Unit
Thermal Resistance, Junction-to-Ambient	$R_{\theta JA}$	75	87	$^\circ\text{C}/\text{W}$
Thermal Resistance, Junction-to-Case	$R_{\theta JC}$	5.8	6.7	$^\circ\text{C}/\text{W}$

Notes:

1. Computed continuous current assumes the condition of T_{J_Max} while the actual continuous current depends on the thermal & electro-mechanical application board design.
2. This single-pulse measurement was taken under $T_{J_Max} = 175^\circ\text{C}$.
3. E_{AS} of 26 mJ is based on starting $T_J = 25^\circ\text{C}$, $L = 3.0\text{mH}$, $I_{AS} = 4.2\text{A}$, $V_{GS} = 10\text{V}$, $V_{DD} = 30\text{V}$; 100% test at $L = 0.3\text{mH}$, $I_{AS} = 10\text{A}$.
4. The power dissipation P_D is based on $T_{J_Max} = 175^\circ\text{C}$.
5. This value is guaranteed by design hence it is not included in the production test.

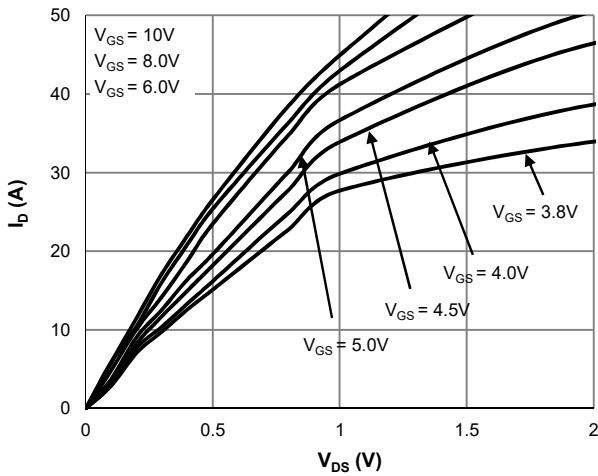
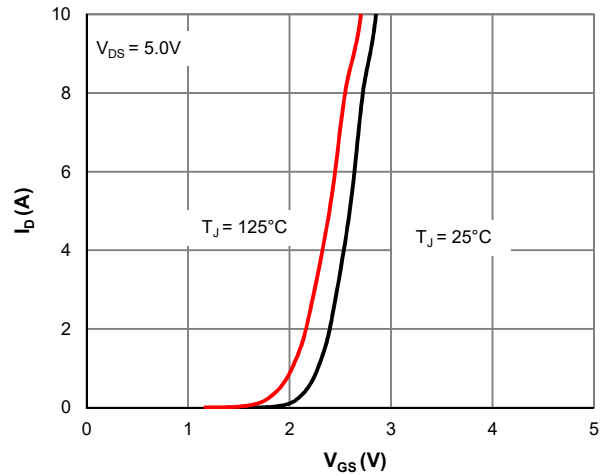
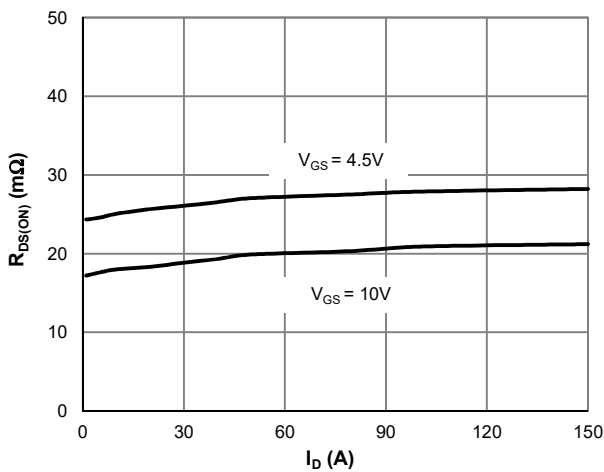
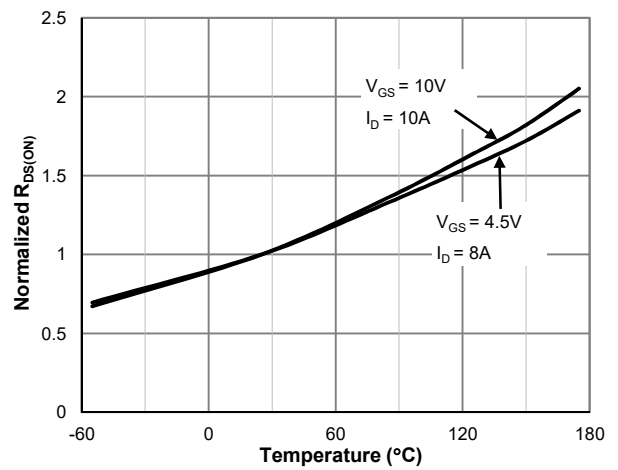
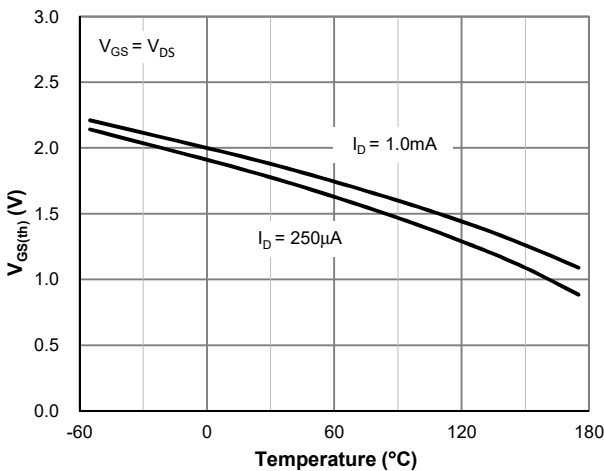
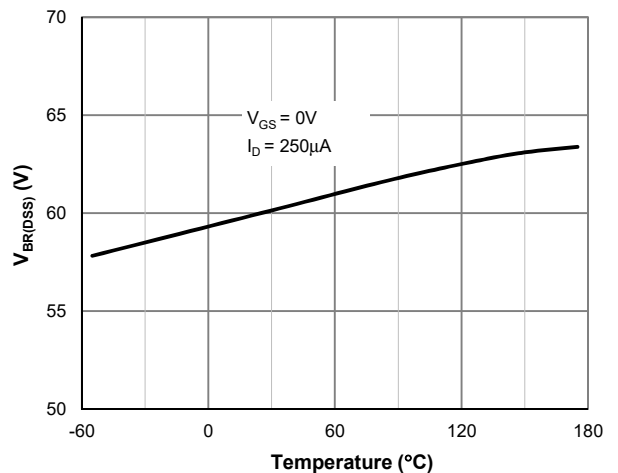
Typical Electrical & Thermal Characteristics

Figure 1: Saturation Characteristics

Figure 2: Transfer Characteristics

Figure 3: $R_{DS(ON)}$ vs. Drain Current

Figure 4: $R_{DS(ON)}$ vs. Junction Temperature

Figure 5: $V_{GS(th)}$ vs. Junction Temperature

Figure 6: $V_{BR(DSS)}$ vs. Junction Temperature

Typical Electrical & Thermal Characteristics

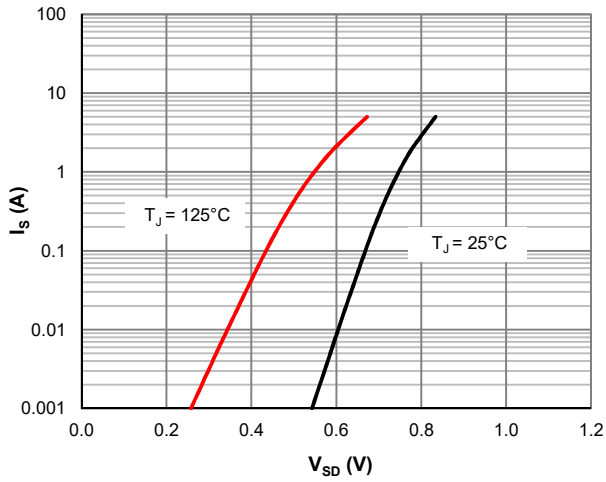

Figure 7: Body-Diode Characteristics

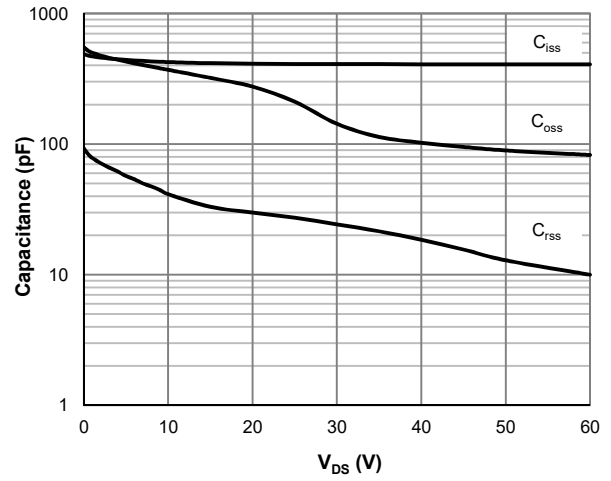

Figure 8: Capacitance Characteristics

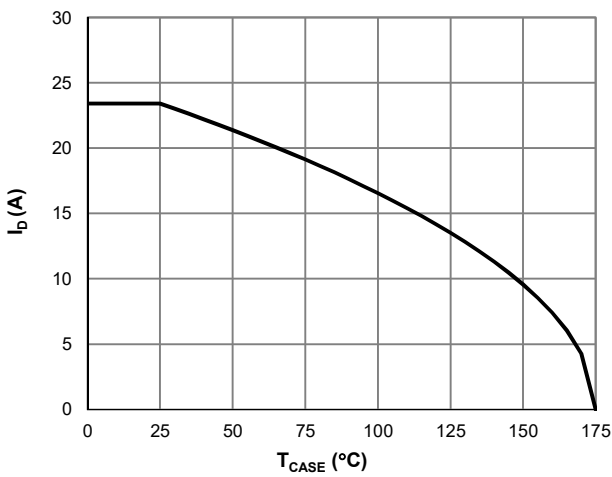

Figure 9: Current De-rating

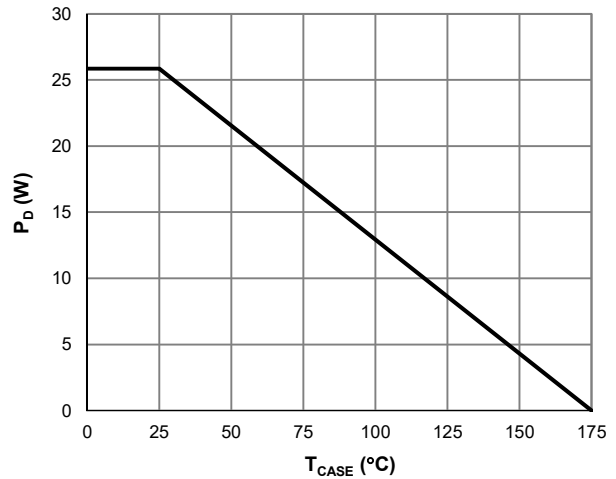

Figure 10: Power De-rating

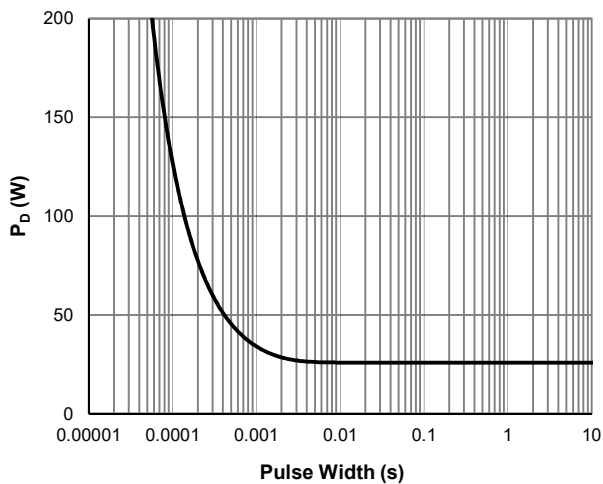

Figure 11: Single Pulse Power Rating, Junction-to-Case

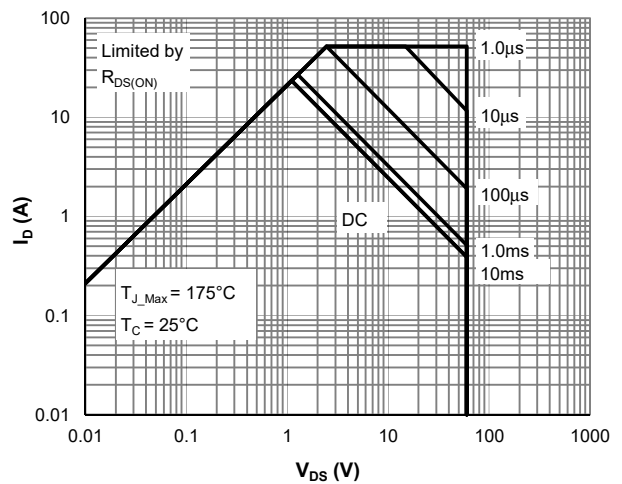

Figure 12: Maximum Safe Operating Area



Typical Electrical & Thermal Characteristics

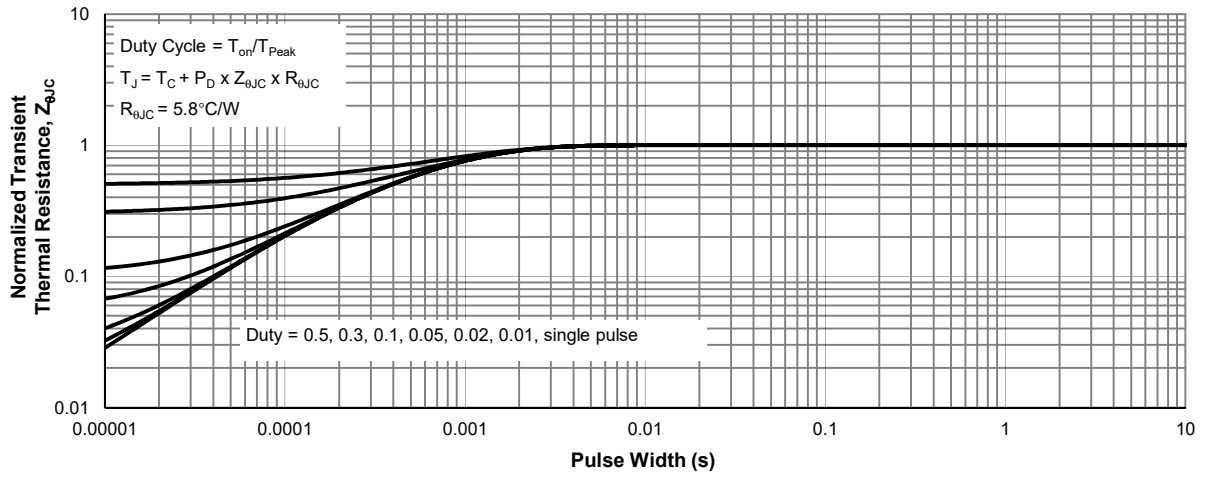
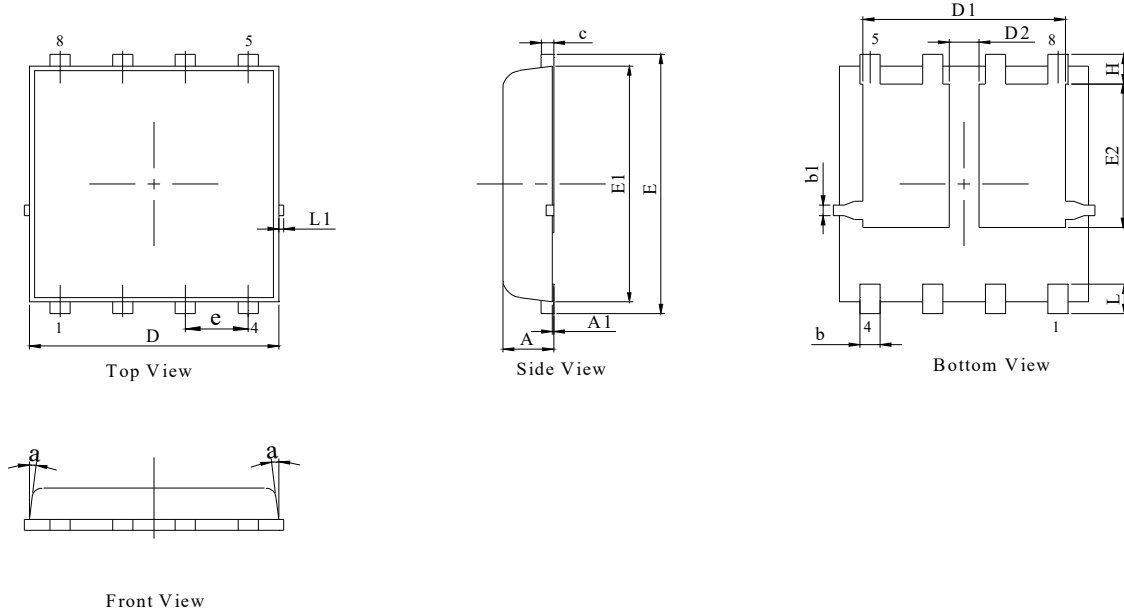
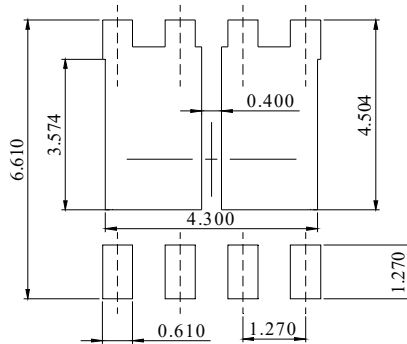

Figure 13: Normalized Maximum Transient Thermal Impedance

PDFN5x6-8L-D Package Information
Package Outline

NOTES:

1. DIMENSIONING AND TOLERANCING PER ASME Y14.5M,1994.
2. ALL DIMNESIONS IN MILLIMETER (ANNGLE IN DEGREE).
3. DIMENSIONS D1 AND E1 DO NOT INCLUDE MOLD FLASH PROTRUSIONS OR GATE BURRS.

DIM.	MILLIMETER		
	MIN.	NOM.	MAX.
A	0.90	1.00	1.10
A1	0.00	-	0.10
b	0.31	0.41	0.51
b1	0.15	0.25	0.35
c	0.23	-	0.33
D	4.95	5.05	5.15
D1	4.00	4.10	4.20
D2	0.50	0.60	0.70
E	6.05	6.15	6.25
E1	5.50	5.60	5.70
E2	3.31	3.41	3.51
e	1.27BSC		
H	0.60	0.70	0.80
L	0.50	0.70	0.80
L1	-	-	0.125
a	-	-	12°

Recommended Soldering Footprint

DIMENSIONS: MILLIMETERS