



# 100V 6.7mΩ N-Ch Power MOSFET

## Features

- Ultra-low  $R_{DS(ON)}$
- Low Gate Charge
- 100% UIS Tested, 100%  $R_g$  Tested
- Pb-free Lead Plating
- Halogen-free and RoHS-compliant

## Product Summary

Parameter	Value	Unit
$V_{DS}$	100	V
$V_{GS(th\_Typ)}$	1.6	V
$I_D$ (@ $V_{GS} = 10V$ ) <sup>(1)</sup>	82	A
$R_{DS(ON\_Typ)}$ (@ $V_{GS} = 10V$ )	6.7	mΩ
$R_{DS(ON\_Typ)}$ (@ $V_{GS} = 4.5V$ )	8.5	mΩ

## Applications

- Power Management in Telecom., Industrial Automation, CE
- Current Switching in DC/DC & AC/DC (SR) Sub-systems
- Motor Driving in Power Tool, E-vehicle, Robotics

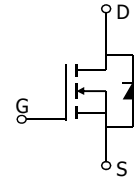
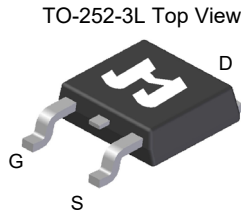

## Ordering Information

Device	Package	# of Pins	Marking	MSL	$T_J$ (°C)	Media	Quantity (pcs)
JMSL1008AK-13	TO-252-3L	3	SL1008A	1	-55 to 150	13-inch Reel	2500

## Absolute Maximum Ratings (@ $T_A = 25^\circ C$ unless otherwise specified)

Parameter	Symbol	Value	Unit
Drain-to-Source Voltage	$V_{DS}$	100	V
Gate-to-Source Voltage	$V_{GS}$	±20	V
Continuous Drain Current <sup>(1)</sup>	$I_D$	$T_C = 25^\circ C$	82
		$T_C = 100^\circ C$	52
Pulsed Drain Current <sup>(2)</sup>	$I_{DM}$	246	A
Avalanche Current <sup>(3)</sup>	$I_{AS}$	42	A
Avalanche Energy <sup>(3)</sup>	$E_{AS}$	88	mJ
Power Dissipation <sup>(4)</sup>	$P_D$	$T_C = 25^\circ C$	104
		$T_C = 100^\circ C$	42
Junction & Storage Temperature Range	$T_J, T_{STG}$	-55 to 150	°C

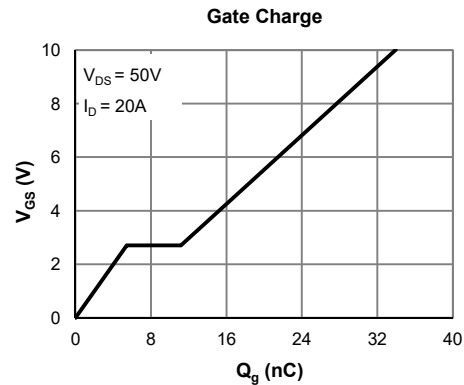
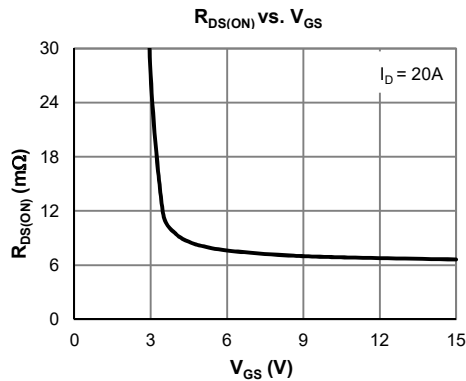

**Electrical Characteristics** (@  $T_J = 25^\circ\text{C}$  unless otherwise specified)

Parameter	Symbol	Conditions	Min.	Typ.	Max.	Unit
<b>STATIC PARAMETERS</b>						
Drain-Source Breakdown Voltage	$V_{(BR)DSS}$	$I_D = 250\mu\text{A}, V_{GS} = 0\text{V}$	100			V
Zero Gate Voltage Drain Current	$I_{DSS}$	$V_{DS} = 80\text{V}, V_{GS} = 0\text{V}$ $T_J = 55^\circ\text{C}$			1.0 5.0	$\mu\text{A}$
Gate-Body Leakage Current	$I_{GSS}$	$V_{DS} = 0\text{V}, V_{GS} = \pm 20\text{V}$			$\pm 100$	nA
Gate Threshold Voltage	$V_{GS(th)}$	$V_{DS} = V_{GS}, I_D = 250\mu\text{A}$	1.2	1.6	2.5	V
Static Drain-Source ON-Resistance	$R_{DS(on)}$	$V_{GS} = 10\text{V}, I_D = 20\text{A}$		6.7	8.1	$\text{m}\Omega$
Static Drain-Source ON-Resistance	$R_{DS(on)}$	$V_{GS} = 4.5\text{V}, I_D = 15\text{A}$		8.5	11.0	$\text{m}\Omega$
Forward Transconductance	$g_{FS}$	$V_{DS} = 5\text{V}, I_D = 20\text{A}$		82		S
Diode Forward Voltage	$V_{SD}$	$I_S = 1\text{A}, V_{GS} = 0\text{V}$		0.71	1.0	V
Diode Continuous Current	$I_S$	$T_C = 25^\circ\text{C}$			104	A
<b>DYNAMIC PARAMETERS</b> <sup>(5)</sup>						
Input Capacitance	$C_{iss}$	$V_{GS} = 0\text{V}, V_{DS} = 50\text{V}, f = 1\text{MHz}$		2360		pF
Output Capacitance	$C_{oss}$			368		pF
Reverse Transfer Capacitance	$C_{rss}$			5.9		pF
Gate Resistance	$R_g$	$V_{GS} = 0\text{V}, V_{DS} = 0\text{V}, f = 1\text{MHz}$		1.7		$\Omega$
<b>SWITCHING PARAMETERS</b> <sup>(5)</sup>						
Total Gate Charge (@ $V_{GS} = 10\text{V}$ )	$Q_g$	$V_{GS} = 0 \text{ to } 10\text{V}$ $V_{DS} = 75\text{V}, I_D = 20\text{A}$		34		nC
Total Gate Charge (@ $V_{GS} = 6.0\text{V}$ )	$Q_g$			16.8		nC
Gate Source Charge	$Q_{gs}$			5.4		nC
Gate Drain Charge	$Q_{gd}$			5.7		nC
Turn-On Delay Time	$t_{D(on)}$	$V_{GS} = 10\text{V}, V_{DS} = 75\text{V}$ $R_L = 3.75\Omega, R_{GEN} = 6\Omega$		8.4		ns
Turn-On Rise Time	$t_r$			12.2		ns
Turn-Off Delay Time	$t_{D(off)}$			43		ns
Turn-Off Fall Time	$t_f$			18.9		ns
Body Diode Reverse Recovery Time	$t_{rr}$		$I_F = 15\text{A}, dI_F/dt = 100\text{A}/\mu\text{s}$		49	
Body Diode Reverse Recovery Charge	$Q_{rr}$	$I_F = 15\text{A}, dI_F/dt = 100\text{A}/\mu\text{s}$		43		nC

**Thermal Performance**

Parameter	Symbol	Typ.	Max.	Unit
Thermal Resistance, Junction-to-Ambient	$R_{\theta JA}$	40	48	$^\circ\text{C}/\text{W}$
Thermal Resistance, Junction-to-Case	$R_{\theta JC}$	0.90	1.2	$^\circ\text{C}/\text{W}$

**Notes:**

1. Computed continuous current assumes the condition of  $T_{J\_Max}$  while the actual continuous current depends on the thermal & electro-mechanical application board design.
2. This single-pulse measurement was taken under  $T_{J\_Max} = 150^\circ\text{C}$ .
3. This single-pulse measurement was taken under the following condition [ $L = 100\mu\text{H}, V_{GS} = 10\text{V}, V_{DD} = 50\text{V}$ ] while its value is limited by  $T_{J\_Max} = 150^\circ\text{C}$ .
4. The power dissipation  $P_D$  is based on  $T_{J\_Max} = 150^\circ\text{C}$ .
5. This value is guaranteed by design hence it is not included in the production test.

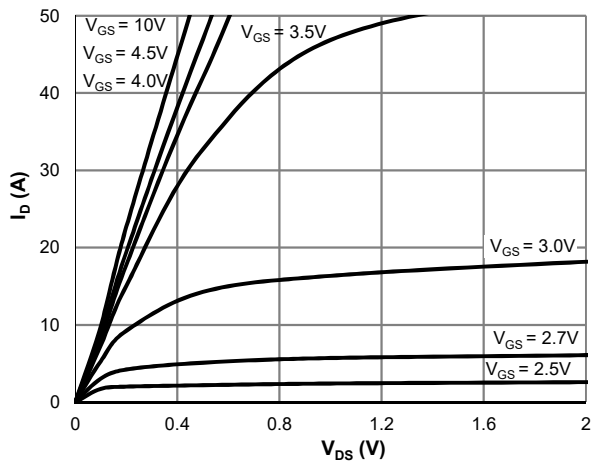
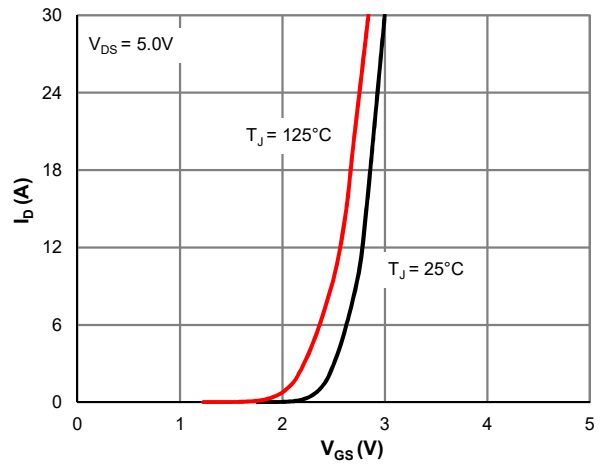
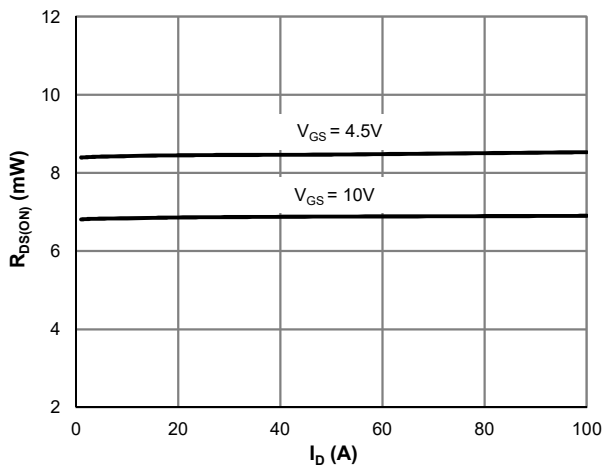
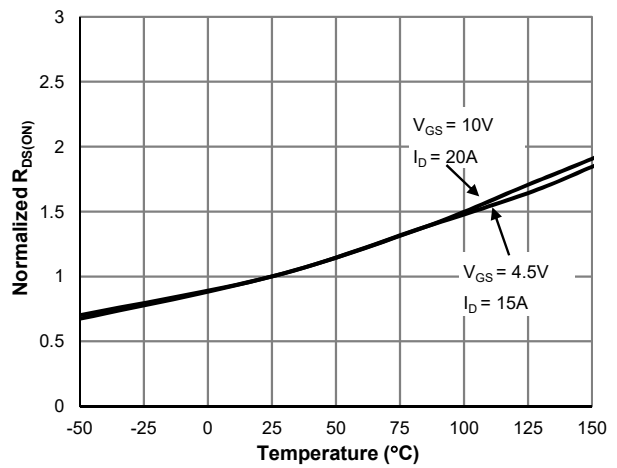
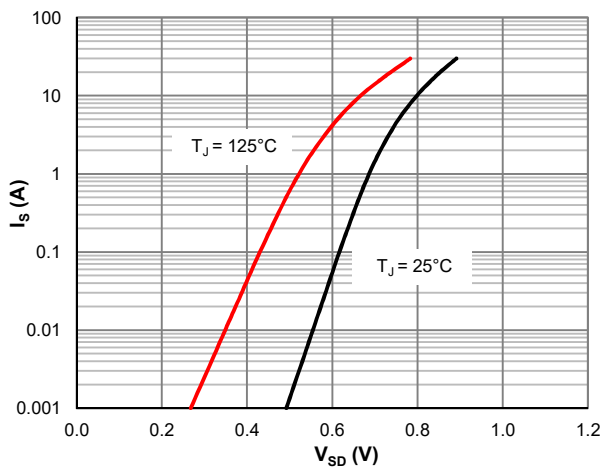
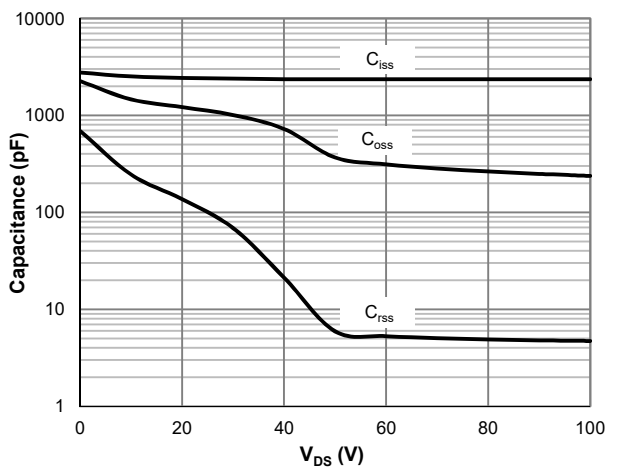
**Typical Electrical & Thermal Characteristics**

**Figure 1: Saturation Characteristics**

**Figure 2: Transfer Characteristics**

**Figure 3:  $R_{DS(ON)}$  vs. Drain Current**

**Figure 4:  $R_{DS(ON)}$  vs. Junction Temperature**

**Figure 5: Body-Diode Characteristics**

**Figure 6: Capacitance Characteristics**

Typical Electrical & Thermal Characteristics

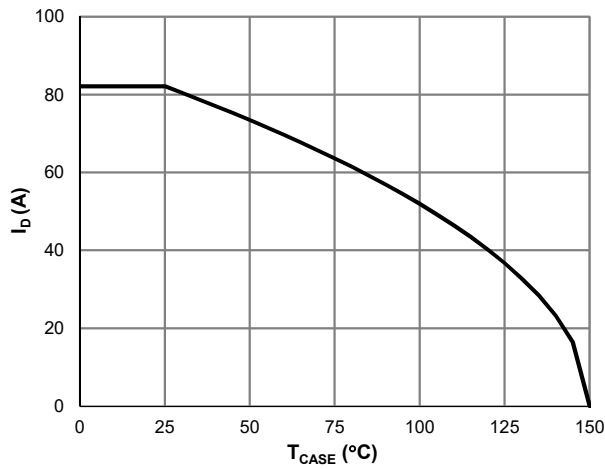

Figure 7: Current De-rating

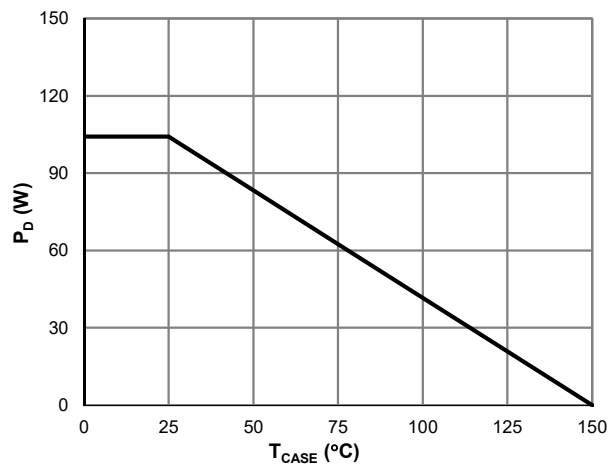

Figure 8: Power De-rating

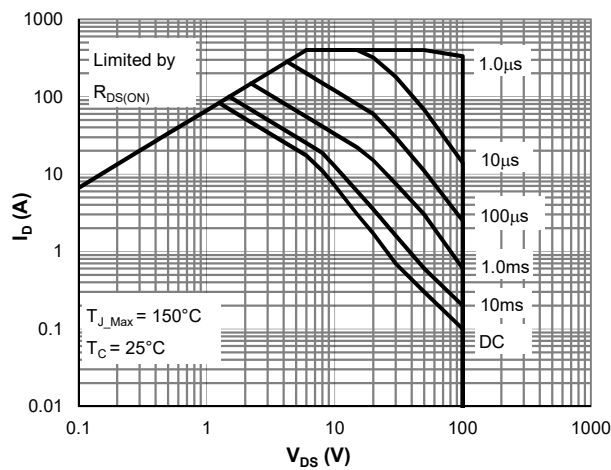

Figure 9: Maximum Safe Operating Area

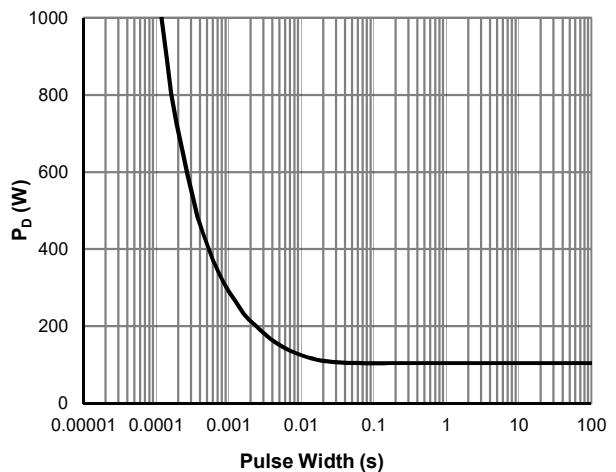

Figure 10: Single Pulse Power Rating, Junction-to-Case

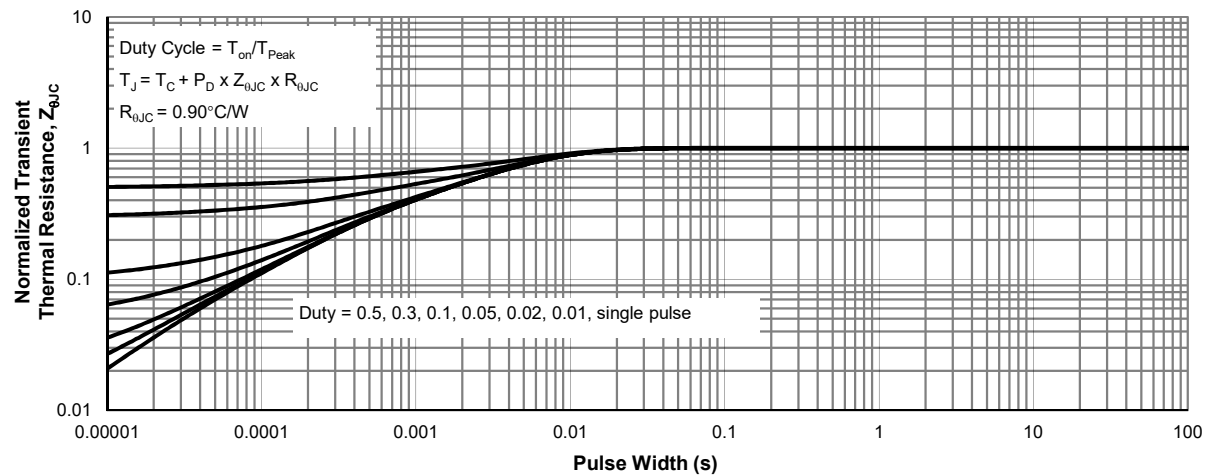
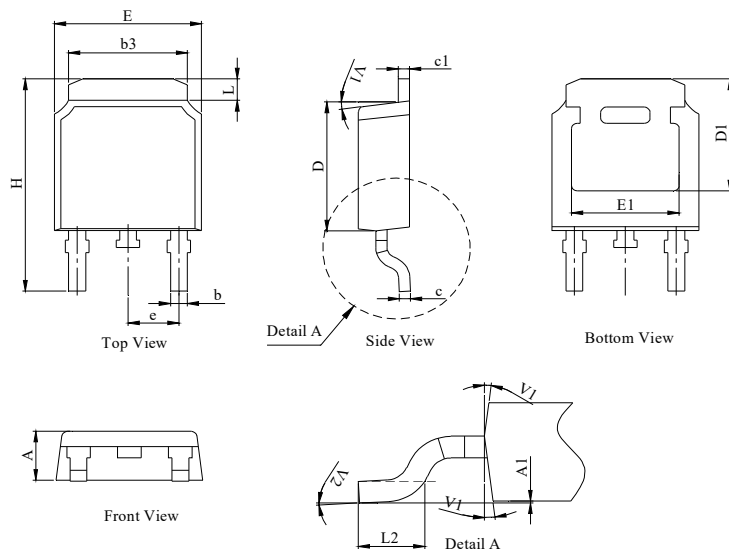
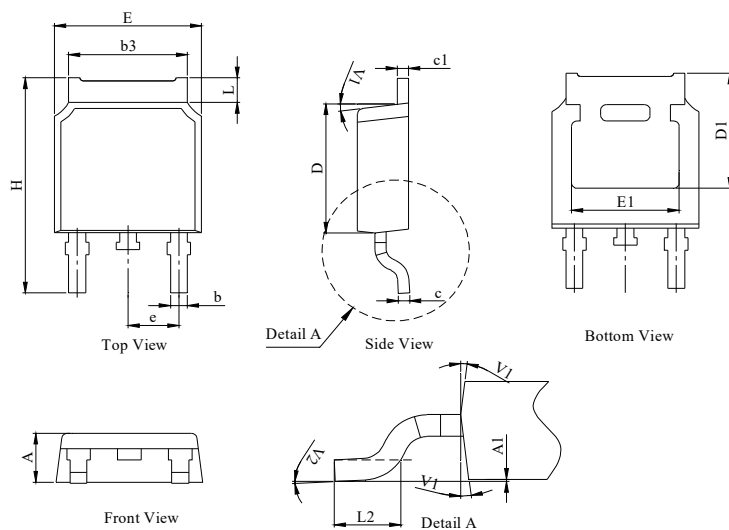

Figure 11: Normalized Maximum Transient Thermal Impedance

**TO-252-3L Package Information**
**Package Outline Type-A**

DIM.	MILLIMETER		
	MIN.	NOM.	MAX.
A	2.18	2.30	2.39
A1	0	--	0.13
b	0.64	0.76	0.89
c	0.40	0.50	0.61
c1	0.46	0.50	0.58
D	5.97	6.10	6.23
D1	5.05	--	--
E	6.35	6.60	6.73
E1	4.32	--	--
b3	5.21	5.38	5.55
e	2.29 BSC		
H	9.40	10.00	10.40
L	0.89	--	1.27
L2	1.40	--	1.78
V1	7° REF		
V2	0°	--	6°

**Package Outline Type-B**

DIM.	MILLIMETER		
	MIN.	NOM.	MAX.
A	2.10	2.30	2.40
A1	0	--	0.13
b	0.66	0.76	0.86
b3	5.21	5.38	5.55
c	0.40	0.50	0.60
c1	0.44	0.50	0.58
D	5.90	6.10	6.30
D1	5.30REF		
E	6.40	6.60	6.80
E1	4.63	-	-
e	2.29 BSC		
H	9.50	10.00	10.70
L	1.09	--	1.21
L2	1.35	--	1.65
V1	7° REF		
V2	0°	--	6°

**Recommended Soldering Footprint**
