



100V 7.8mΩ N-Ch Power MOSFET

Features

- Ultra-low ON-resistance, $R_{DS(ON)}$
- Low Gate Charge, Q_g
- 100% UIS and R_g Tested
- Pb-free Lead Plating
- Halogen-free and RoHS-compliant
- AEC-Q101 Qualified for Automotive Applications

Product Summary

Parameter	Value	Unit
V_{DS}	100	V
$V_{GS(th_Typ)}$	1.7	V
I_D (@ $V_{GS} = 10V$) ⁽¹⁾	81	A
$R_{DS(ON_Typ)}$ (@ $V_{GS} = 10V$)	7.8	mΩ
$R_{DS(ON_Typ)}$ (@ $V_{GS} = 4.5V$)	9.9	mΩ

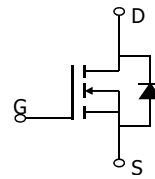
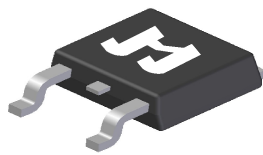

Ordering Information

Device	Package	# of Pins	Marking	MSL	T_J (°C)	Media	Quantity (pcs)
JMSL1009AKQ-13	TO-252-3L	3	SL1009AQ	1	-55 to 175	13-inch Reel	2500

Absolute Maximum Ratings (@ $T_A = 25^\circ C$ unless otherwise specified)

Parameter	Symbol	Value	Unit
Drain-to-Source Voltage	V_{DS}	100	V
Gate-to-Source Voltage	V_{GS}	±20	V
Continuous Drain Current ⁽¹⁾	I_D	$T_C = 25^\circ C$	81
		$T_C = 100^\circ C$	57
Pulsed Drain Current ⁽²⁾	I_{DM}	291	A
Avalanche Energy ⁽³⁾	E_{AS}	165	mJ
Power Dissipation ⁽⁴⁾	P_D	$T_C = 25^\circ C$	125
		$T_C = 100^\circ C$	63
Junction & Storage Temperature Range	T_J, T_{STG}	-55 to 175	°C

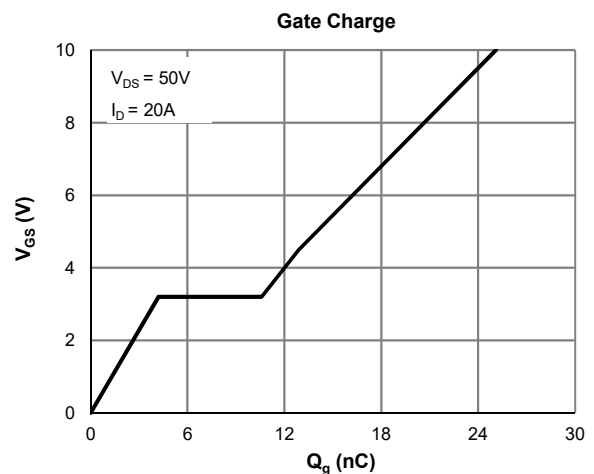
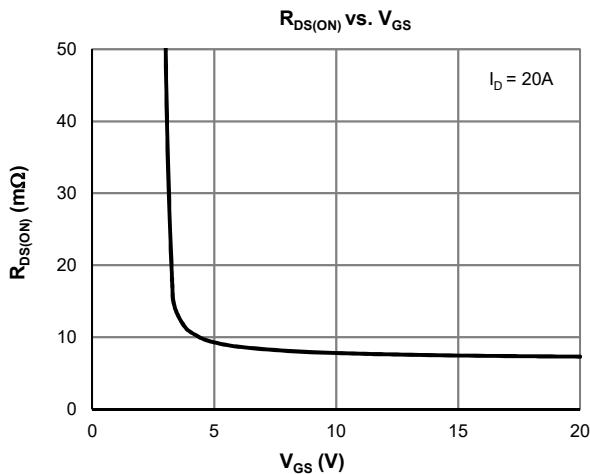



Electrical Characteristics (@ $T_J = 25^\circ\text{C}$ unless otherwise specified)

Parameter	Symbol	Conditions	Min.	Typ.	Max.	Unit
STATIC PARAMETERS						
Drain-Source Breakdown Voltage	$V_{(BR)DSS}$	$I_D = 250\mu\text{A}, V_{GS} = 0\text{V}$	100			V
Zero Gate Voltage Drain Current	I_{DSS}	$V_{DS} = 80\text{V}, V_{GS} = 0\text{V}$ $T_J = 55^\circ\text{C}$			1.0 5.0	μA
Gate-Body Leakage Current	I_{GSS}	$V_{DS} = 0\text{V}, V_{GS} = \pm 20\text{V}$			± 100	nA
Gate Threshold Voltage	$V_{GS(th)}$	$V_{DS} = V_{GS}, I_D = 250\mu\text{A}$	1.2	1.7	2.5	V
Static Drain-Source ON-Resistance	$R_{DS(ON)}$	$V_{GS} = 10\text{V}, I_D = 20\text{A}$		7.8	9.4	$\text{m}\Omega$
	$R_{DS(ON)}$	$V_{GS} = 4.5\text{V}, I_D = 15\text{A}$		9.9	12.9	$\text{m}\Omega$
Forward Transconductance	g_{FS}	$V_{DS} = 5\text{V}, I_D = 10\text{A}$		127		S
Diode Forward Voltage	V_{SD}	$I_S = 1\text{A}, V_{GS} = 0\text{V}$		0.68	1.0	V
Diode Continuous Current	I_S	$T_C = 25^\circ\text{C}$			125	A

DYNAMIC PARAMETERS ⁽⁵⁾

Input Capacitance	C_{iss}	$V_{GS} = 0\text{V}, V_{DS} = 50\text{V}, f = 1\text{MHz}$		1314		pF
Output Capacitance	C_{oss}			548		pF
Reverse Transfer Capacitance	C_{rss}			26		pF
Gate Resistance	R_g	$V_{GS} = 0\text{V}, V_{DS} = 0\text{V}, f = 1\text{MHz}$		1.6		Ω

SWITCHING PARAMETERS ⁽⁵⁾

Total Gate Charge (@ $V_{GS} = 10\text{V}$)	Q_g	$V_{GS} = 0 \text{ to } 10\text{V}$ $V_{DS} = 50\text{V}, I_D = 20\text{A}$		25		nC
Total Gate Charge (@ $V_{GS} = 4.5\text{V}$)	Q_g			12.9		nC
Gate Source Charge	Q_{gs}			4.2		nC
Gate Drain Charge	Q_{gd}			6.3		nC
Turn-On DelayTime	$t_{D(on)}$	$V_{GS} = 10\text{V}, V_{DS} = 50\text{V}$ $R_L = 2.5\Omega, R_{GEN} = 6\Omega$		10.6		ns
Turn-On Rise Time	t_r			53		ns
Turn-Off DelayTime	$t_{D(off)}$			34		ns
Turn-Off Fall Time	t_f			108		ns
Body Diode Reverse Recovery Time	t_{rr}		$I_F = 20\text{A}, di_F/dt = 100\text{A}/\mu\text{s}$		55	
Body Diode Reverse Recovery Charge	Q_{rr}	$I_F = 20\text{A}, di_F/dt = 100\text{A}/\mu\text{s}$		39		nC

Thermal Performance

Parameter	Symbol	Typ.	Max.	Unit
Thermal Resistance, Junction-to-Ambient	$R_{\theta JA}$	40	50	$^\circ\text{C}/\text{W}$
Thermal Resistance, Junction-to-Case	$R_{\theta JC}$	1.2	1.5	$^\circ\text{C}/\text{W}$

Notes:

1. Computed continuous current assumes the condition of T_{J_Max} while the actual continuous current depends on the thermal & electro-mechanical application board design.
2. This single-pulse measurement was taken under $T_{J_Max} = 175^\circ\text{C}$.
3. E_{AS} of 165 mJ is based on starting $T_J = 25^\circ\text{C}$, $L = 3.0\text{mH}$, $I_{AS} = 10.5\text{A}$, $V_{GS} = 10\text{V}$, $V_{DD} = 75\text{V}$; 100% test at $L = 0.3\text{mH}$, $I_{AS} = 24\text{A}$.
4. The power dissipation P_D is based on $T_{J_Max} = 175^\circ\text{C}$.
5. This value is guaranteed by design hence it is not included in the production test.

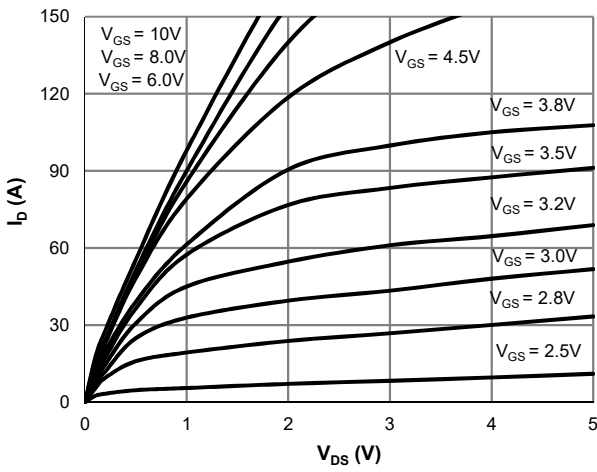
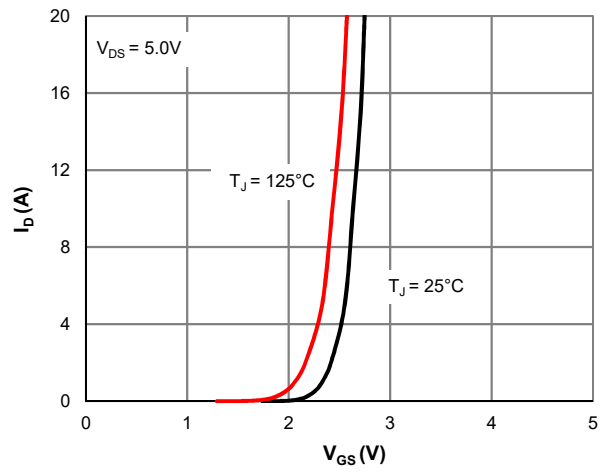
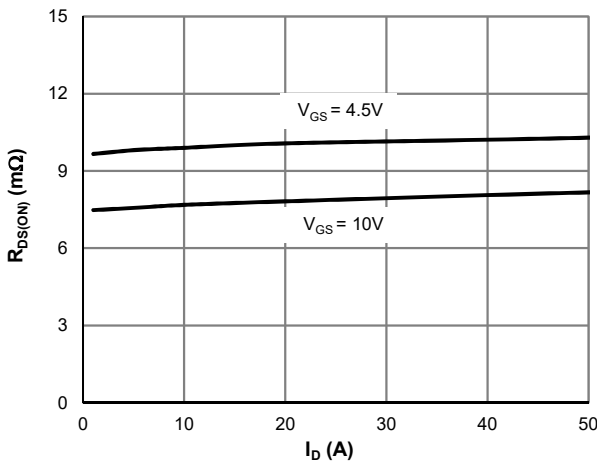
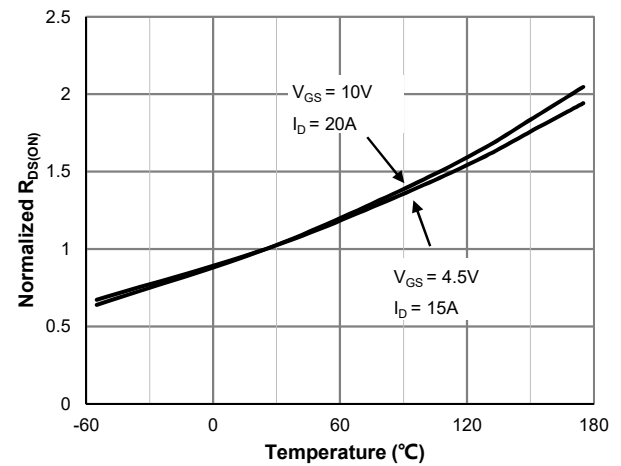
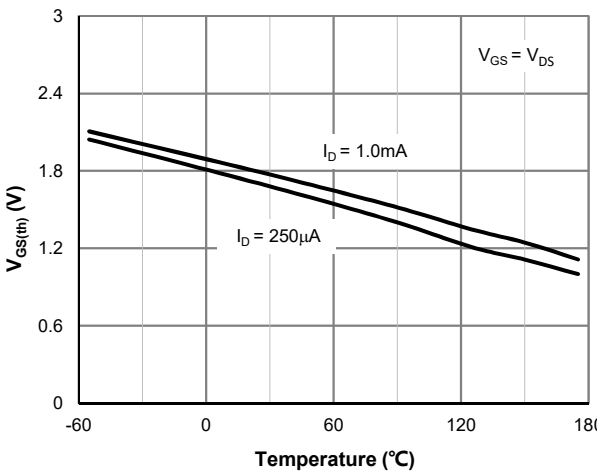
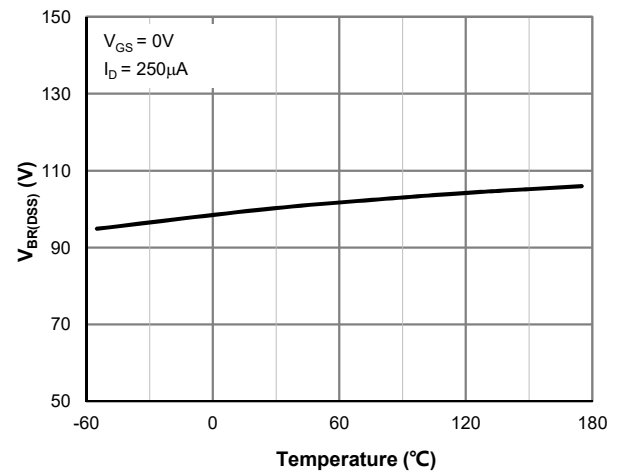
Typical Electrical & Thermal Characteristics

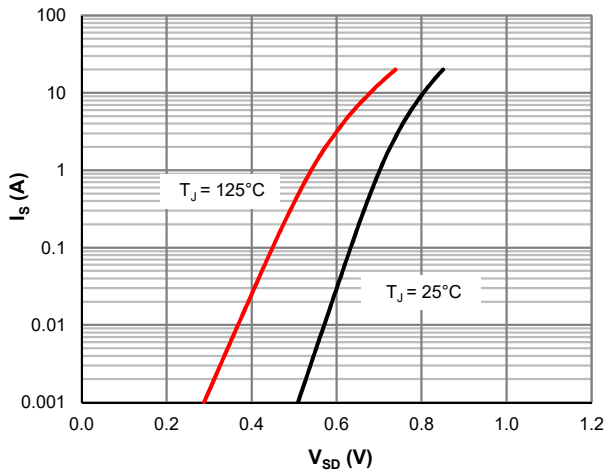
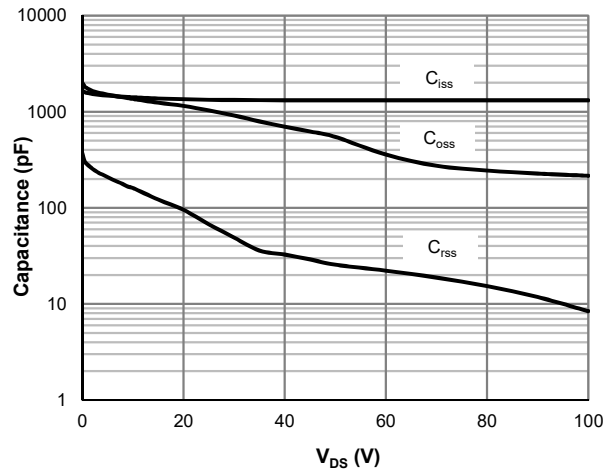
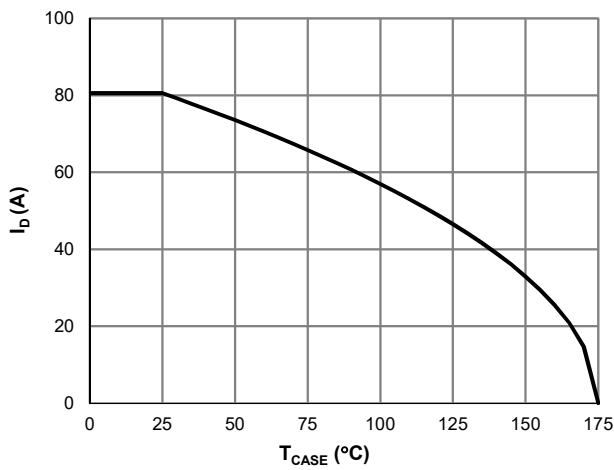
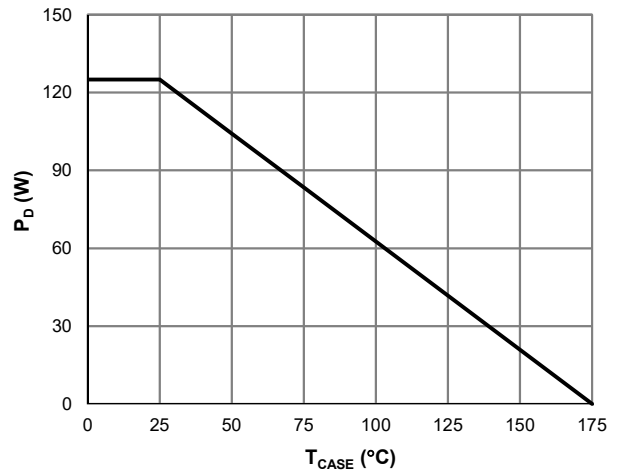
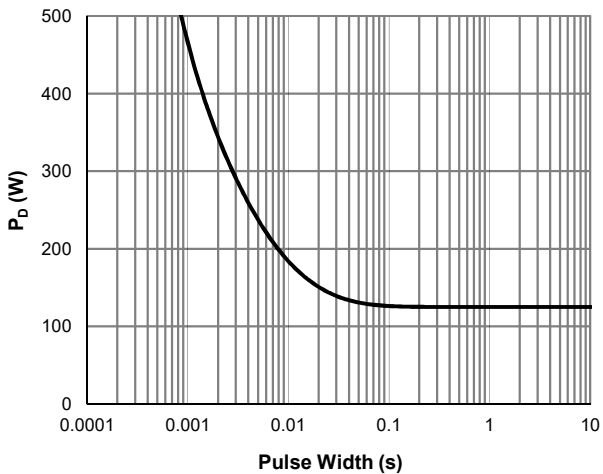
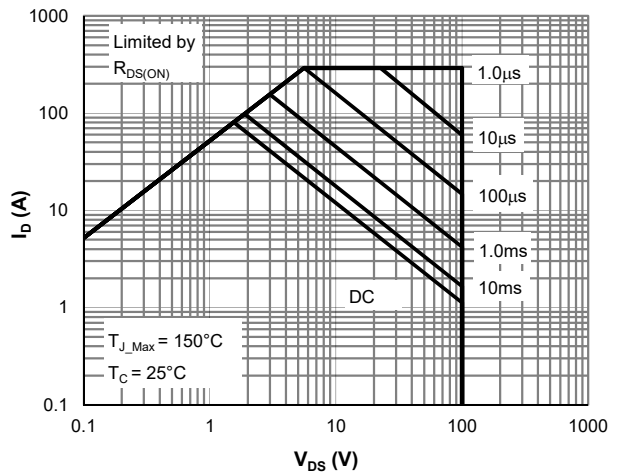
Figure 1: Saturation Characteristics

Figure 2: Transfer Characteristics

Figure 3: $R_{DS(ON)}$ vs. Drain Current

Figure 4: $R_{DS(ON)}$ vs. Junction Temperature

Figure 5: $V_{GS(th)}$ vs. Junction Temperature

Figure 6: $V_{BR(DSS)}$ vs. Junction Temperature

Typical Electrical & Thermal Characteristics

Figure 7: Body-Diode Characteristics

Figure 8: Capacitance Characteristics

Figure 9: Current De-rating

Figure 10: Power De-rating

Figure 11: Single Pulse Power Rating, Junction-to-Case

Figure 12: Maximum Safe Operating Area



Typical Electrical & Thermal Characteristics

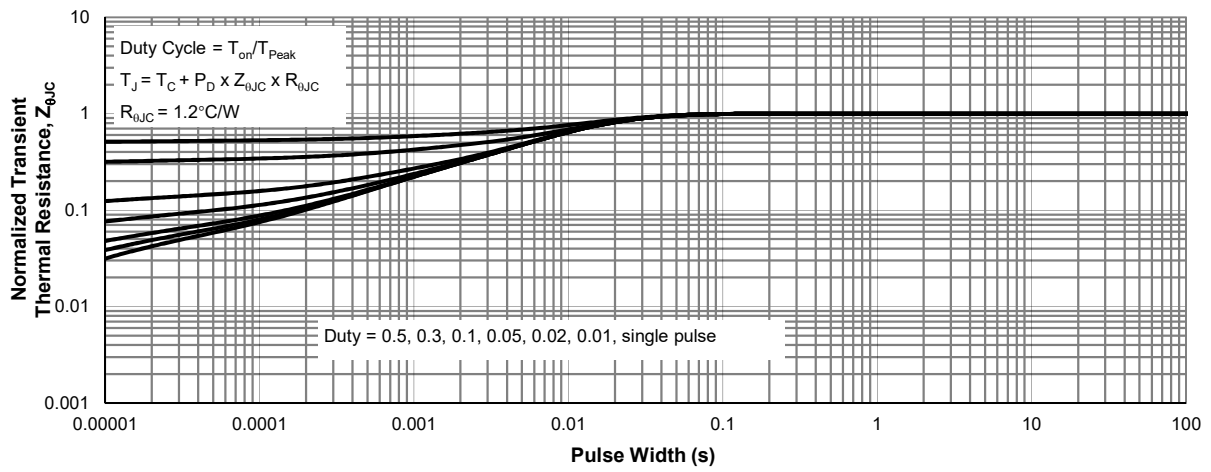
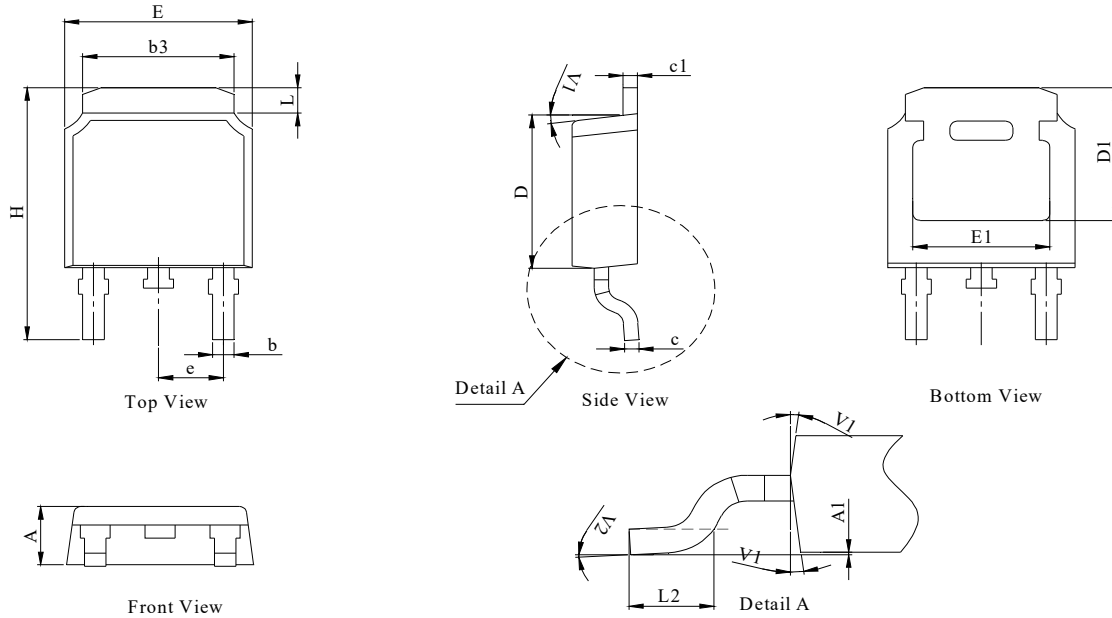
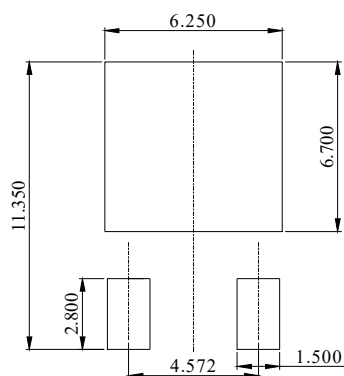

Figure 13: Normalized Maximum Transient Thermal Impedance

TO-252-3L Package Information
Package Outline

DIM.	MILLIMETER		
	MIN.	NOM.	MAX.
A	2.18	2.30	2.39
A1	0	-	0.13
b	0.64	0.76	0.89
c	0.40	0.50	0.61
c1	0.46	0.50	0.58
D	5.97	6.10	6.23
D1	5.05	--	--
E	6.35	6.60	6.73
E1	4.32	--	--
b3	5.21	5.38	5.55
e	2.29 BSC		
H	9.40	10.00	10.40
L	0.89	--	1.27
L2	1.40	--	1.78
V1	7° REF		
V2	0°	-	6°

Recommend Soldering Footprint

DIMENSIONS: MILLIMETERS