



# 150V 4.0mΩ N-Ch Power MOSFET

## Features

- Ultra-low  $R_{DS(ON)}$
- Low Gate Charge
- 100% UIS Tested, 100%  $R_g$  Tested
- Pb-free Lead Plating
- Halogen-free and RoHS-compliant

## Product Summary

Parameter	Value	Unit
$V_{DS}$	150	V
$V_{GS(th)}_{Typ}$	3.2	V
$I_D$ (@ $V_{GS} = 10V$ ) <sup>(1)</sup>	203	A
$R_{DS(ON)}_{Typ}$ (@ $V_{GS} = 10V$ )	4.0	mΩ

## Applications

- Power Management in Telecom., Industrial Automation, CE
- Current Switching in DC/DC & AC/DC (SR) Sub-systems
- Motor Driving in Power Tool, E-vehicle, Robotics

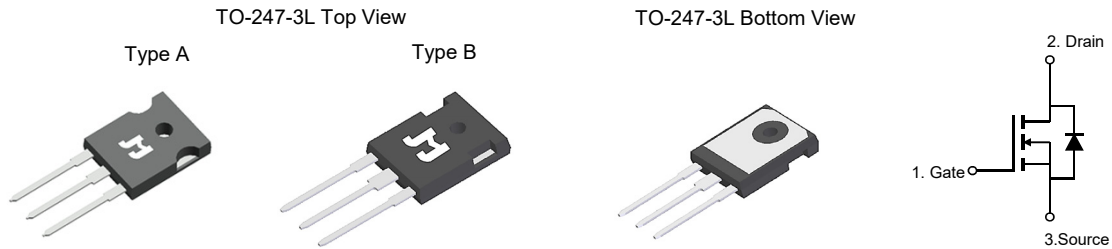

## Ordering Information

Device	Package	# of Pins	Marking	MSL	$T_J$ (°C)	Media	Quantity (pcs)
JMSH1504AS-U	TO-247-3L	3	SH1504A	N/A	-55 to 150	Tube	30

## Absolute Maximum Ratings (@ $T_A = 25^\circ C$ unless otherwise specified)

Parameter	Symbol	Value	Unit
Drain-to-Source Voltage	$V_{DS}$	150	V
Gate-to-Source Voltage	$V_{GS}$	±20	V
Continuous Drain Current <sup>(1)</sup>	$I_D$	$T_C = 25^\circ C$	203
		$T_C = 100^\circ C$	128
Pulsed Drain Current <sup>(2)</sup>	$I_{DM}$	630	A
Avalanche Current <sup>(3)</sup>	$I_{AS}$	77	A
Avalanche Energy <sup>(3)</sup>	$E_{AS}$	889	mJ
Power Dissipation <sup>(4)</sup>	$P_D$	$T_C = 25^\circ C$	417
		$T_C = 100^\circ C$	167
Junction & Storage Temperature Range	$T_J, T_{STG}$	-55 to 150	°C

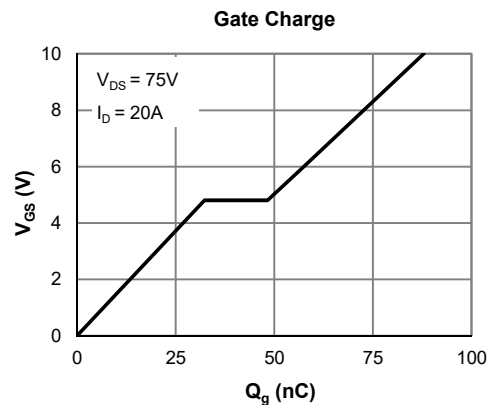
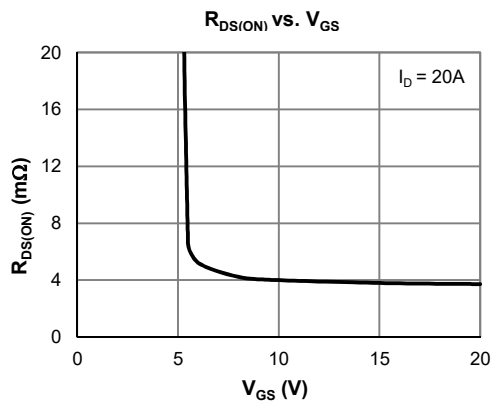

**Electrical Characteristics** (@  $T_J = 25^\circ\text{C}$  unless otherwise specified)

Parameter	Symbol	Conditions	Min.	Typ.	Max.	Unit
<b>STATIC PARAMETERS</b>						
Drain-Source Breakdown Voltage	$V_{(BR)DSS}$	$I_D = 250\mu\text{A}$ , $V_{GS} = 0\text{V}$	150			V
Zero Gate Voltage Drain Current	$I_{DSS}$	$V_{DS} = 120\text{V}$ , $V_{GS} = 0\text{V}$			1.0	$\mu\text{A}$
					5.0	
Gate-Body Leakage Current	$I_{GSS}$	$V_{DS} = 0\text{V}$ , $V_{GS} = \pm 20\text{V}$			$\pm 100$	nA
Gate Threshold Voltage	$V_{GS(th)}$	$V_{DS} = V_{GS}$ , $I_D = 250\mu\text{A}$	2.5	3.2	4.5	V
Static Drain-Source ON-Resistance	$R_{DS(ON)}$	$V_{GS} = 10\text{V}$ , $I_D = 20\text{A}$		4.0	4.9	$\text{m}\Omega$
Forward Transconductance	$g_{FS}$	$V_{DS} = 5\text{V}$ , $I_D = 20\text{A}$		65		S
Diode Forward Voltage	$V_{SD}$	$I_S = 1\text{A}$ , $V_{GS} = 0\text{V}$		0.71	1.0	V
Diode Continuous Current	$I_S$	$T_C = 25^\circ\text{C}$			417	A
<b>DYNAMIC PARAMETERS</b> <sup>(5)</sup>						
Input Capacitance	$C_{iss}$	$V_{GS} = 0\text{V}$ , $V_{DS} = 75\text{V}$ , $f = 1\text{MHz}$		6540		pF
Output Capacitance	$C_{oss}$			772		pF
Reverse Transfer Capacitance	$C_{rss}$			6.7		pF
Gate Resistance	$R_g$	$V_{GS} = 0\text{V}$ , $V_{DS} = 0\text{V}$ , $f = 1\text{MHz}$		2.4		$\Omega$
<b>SWITCHING PARAMETERS</b> <sup>(5)</sup>						
Total Gate Charge (@ $V_{GS} = 10\text{V}$ )	$Q_g$	$V_{GS} = 0$ to $10\text{V}$ $V_{DS} = 75\text{V}$ , $I_D = 20\text{A}$		88		nC
Total Gate Charge (@ $V_{GS} = 6.0\text{V}$ )	$Q_g$			57		nC
Gate Source Charge	$Q_{gs}$			32		nC
Gate Drain Charge	$Q_{gd}$			16		nC
Turn-On DelayTime	$t_{D(on)}$	$V_{GS} = 10\text{V}$ , $V_{DS} = 75\text{V}$ $R_L = 3.75\Omega$ , $R_{GEN} = 6\Omega$		48		ns
Turn-On Rise Time	$t_r$			90		ns
Turn-Off DelayTime	$t_{D(off)}$			94		ns
Turn-Off Fall Time	$t_f$			60		ns
Body Diode Reverse Recovery Time	$t_{rr}$		$I_F = 15\text{A}$ , $di_F/dt = 100\text{A}/\mu\text{S}$		122	
Body Diode Reverse Recovery Charge	$Q_{rr}$	$I_F = 15\text{A}$ , $di_F/dt = 100\text{A}/\mu\text{S}$		279		nC

**Thermal Performance**

Parameter	Symbol	Typ.	Max.	Unit
Thermal Resistance, Junction-to-Ambient	$R_{\theta JA}$	40	48	$^\circ\text{C}/\text{W}$
Thermal Resistance, Junction-to-Case	$R_{\theta JC}$	0.25	0.30	$^\circ\text{C}/\text{W}$

**Notes:**

1. Computed continuous current assumes the condition of  $T_{J\_Max}$  while the actual continuous current depends on the thermal & electro-mechanical application board design.
2. This single-pulse measurement was taken under  $T_{J\_Max} = 150^\circ\text{C}$ .
3. This single-pulse measurement was taken under the following condition [ $L = 300\mu\text{H}$ ,  $V_{GS} = 10\text{V}$ ,  $V_{DS} = 75\text{V}$ ] while its value is limited by  $T_{J\_Max} = 150^\circ\text{C}$ .
4. The power dissipation  $P_D$  is based on  $T_{J\_Max} = 150^\circ\text{C}$ .
5. This value is guaranteed by design hence it is not included in the production test.

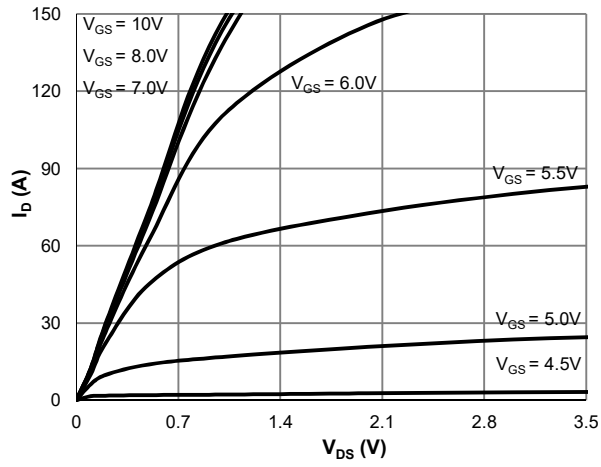
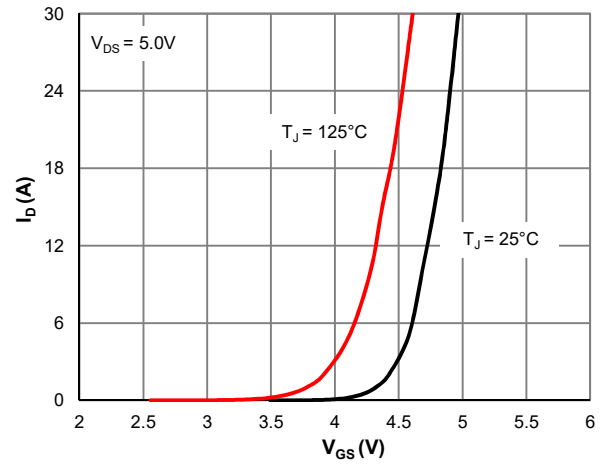
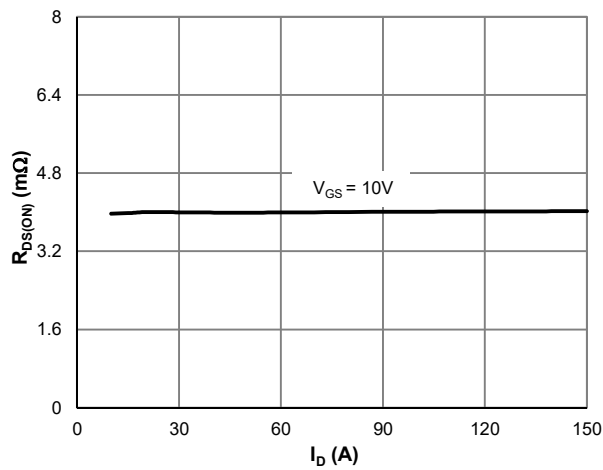
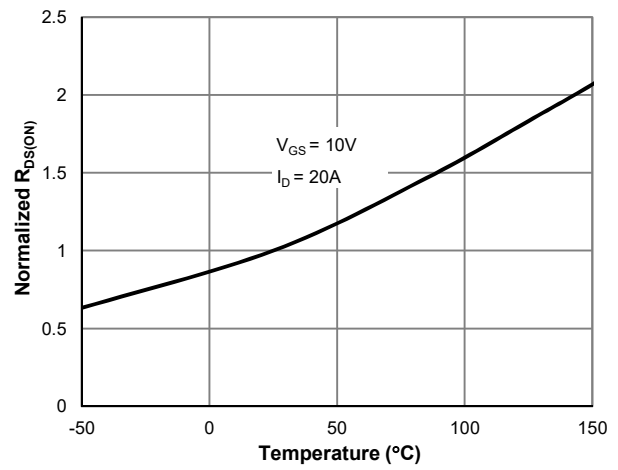
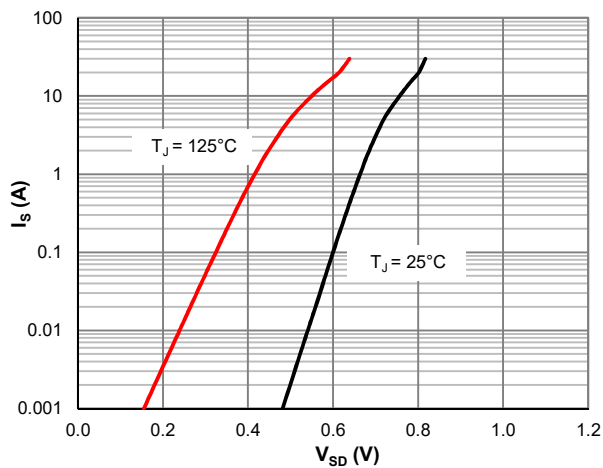
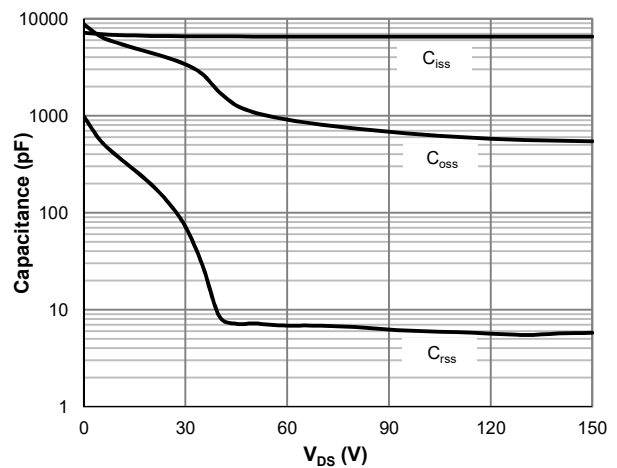
**Typical Electrical & Thermal Characteristics**

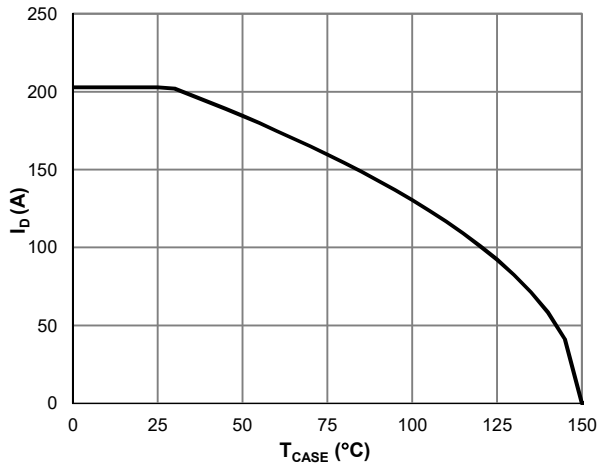
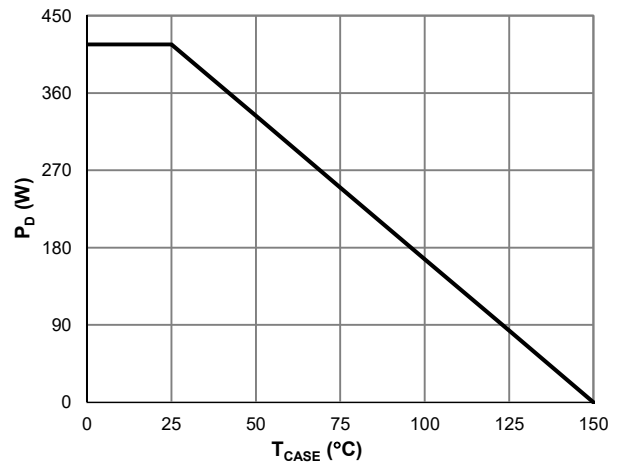
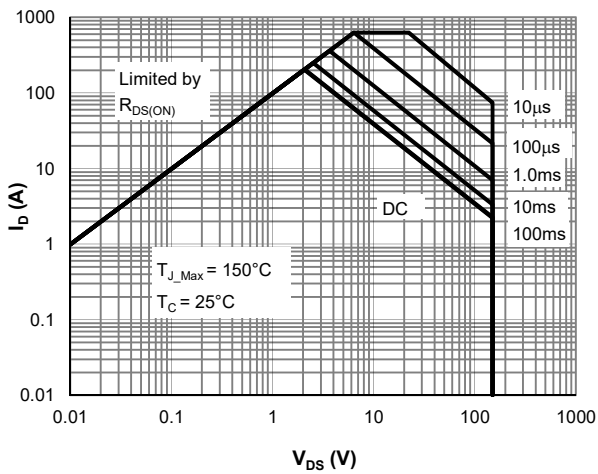
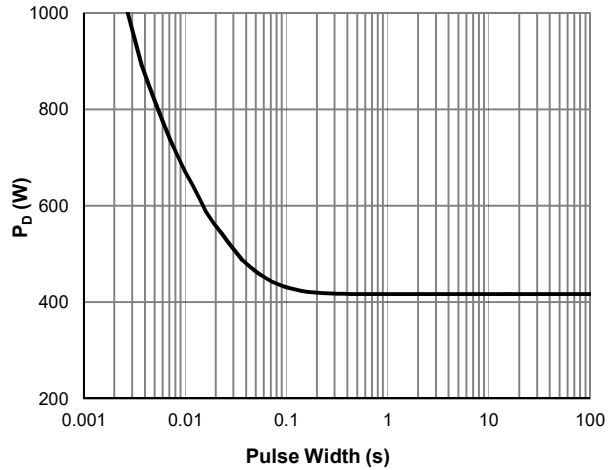
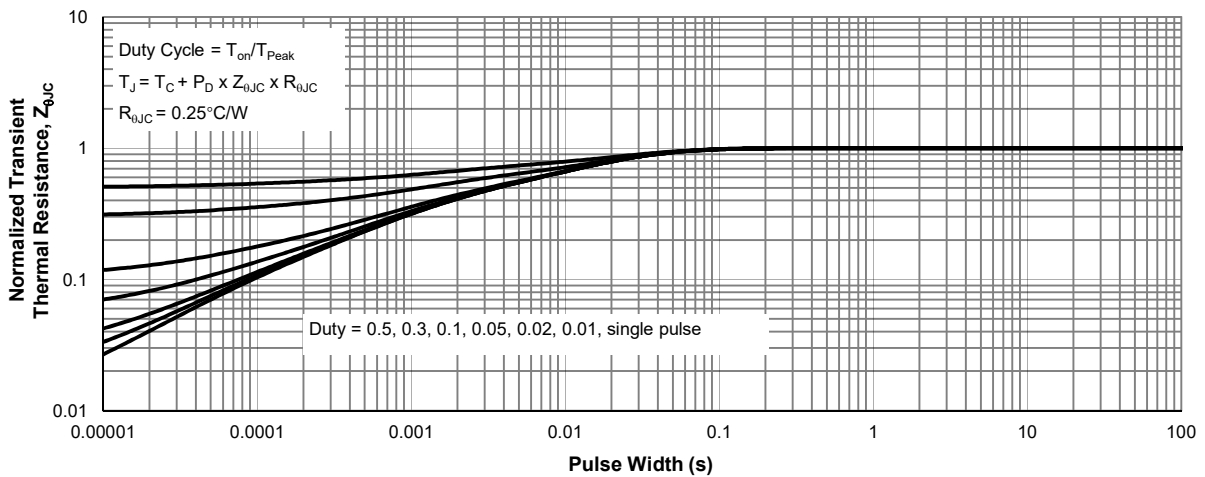
**Figure 1: Saturation Characteristics**

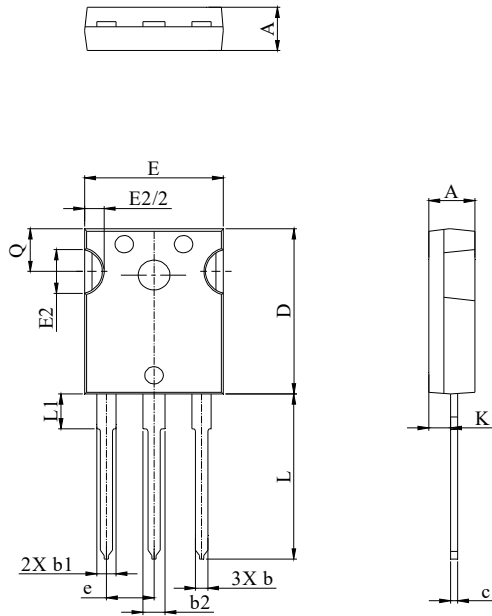
**Figure 2: Transfer Characteristics**

**Figure 3:  $R_{DS(ON)}$  vs. Drain Current**

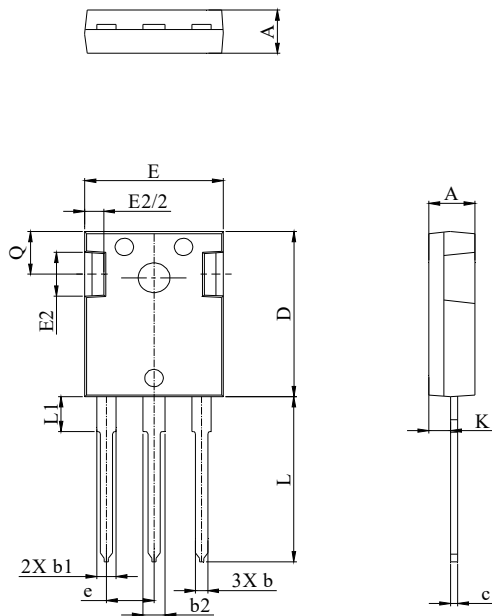
**Figure 4:  $R_{DS(ON)}$  vs. Junction Temperature**

**Figure 5: Body-Diode Characteristics**

**Figure 6: Capacitance Characteristics**

**Typical Electrical & Thermal Characteristics**

**Figure 7: Current De-rating**

**Figure 8: Power De-rating**

**Figure 9: Maximum Safe Operating Area**

**Figure 10: Single Pulse Power Rating, Junction-to-Case**

**Figure 11: Normalized Maximum Transient Thermal Impedance**

**TO-247-3L Package Information**
**Type\_A Package Outline**

DIM.	MILLIMETER		
	MIN.	NOM.	MAX.
A	4.80	5.02	5.21
b	1.00	1.20	1.40
b1	1.90	2.00	2.39
b2	2.87	3.00	3.22
c	0.41	0.60	0.79
D	20.80	21.00	21.20
E	15.50	15.94	16.13
E2	4.32	-	5.49
L	19.70	20.07	20.32
L1	4.00	-	4.40
K	2.20	-	2.50
Q	-	5.80	-
e	5.44 BSC		

**Type\_B Package Outline**

DIM.	MILLIMETER		
	MIN.	NOM.	MAX.
A	4.80	5.02	5.21
b	1.00	1.20	1.40
b1	1.90	2.00	2.39
b2	2.87	3.00	3.22
c	0.41	0.60	0.79
D	20.80	21.00	21.20
E	15.50	15.94	16.13
E2	4.32	-	5.49
L	19.70	20.07	20.32
L1	4.00	-	4.40
K	2.20	-	2.50
Q	-	5.80	-
e	5.44 BSC		