



100V 29mΩ N-Ch Power MOSFET

Features

- Low $R_{DS(ON)}$
- Low Gate Charge
- 100% UIS Tested, 100% R_g Tested
- Pb-free Lead Plating
- Halogen-free and RoHS-compliant

Product Summary

Parameter	Value	Unit
V_{DS}	100	V
$V_{GS(th_Typ)}$	2.0	V
I_D (@ $V_{GS} = 10V$) ⁽¹⁾	18.9	A
$R_{DS(ON_Typ)}$ (@ $V_{GS} = 10V$)	29	mΩ
$R_{DS(ON_Typ)}$ (@ $V_{GS} = 4.5V$)	39	mΩ

Applications

- Power Management in Telecom., Industrial Automation, CE
- Current Switching in DC/DC & AC/DC Sub-systems
- Motor Driving in Power Tool, E-vehicle, Robotics

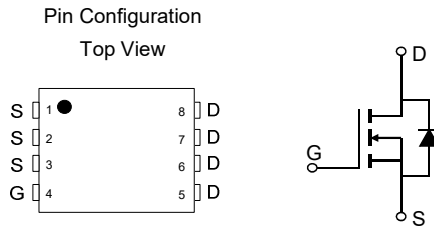
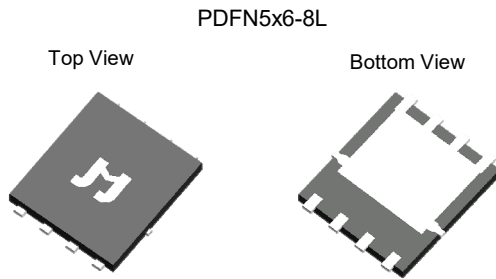

Ordering Information

Device	Package	# of Pins	Marking	MSL	T_J (°C)	Media	Quantity (pcs)
JMSL1040AG-13	PDFN5x6-8L	8	SL1040A	1	-55 to 150	13-inch Reel	5000

Absolute Maximum Ratings (@ $T_A = 25^\circ C$ unless otherwise specified)

Parameter	Symbol	Value	Unit
Drain-to-Source Voltage	V_{DS}	100	V
Gate-to-Source Voltage	V_{GS}	±20	V
Continuous Drain Current ⁽¹⁾	I_D	$T_C = 25^\circ C$	18.9
		$T_C = 100^\circ C$	12.0
Pulsed Drain Current ⁽²⁾	I_{DM}	76	A
Avalanche Current ⁽³⁾	I_{AS}	15.0	A
Avalanche Energy ⁽³⁾	E_{AS}	11.3	mJ
Power Dissipation ⁽⁴⁾	P_D	$T_C = 25^\circ C$	24
		$T_C = 100^\circ C$	9.6
Junction & Storage Temperature Range	T_J, T_{STG}	-55 to 150	°C

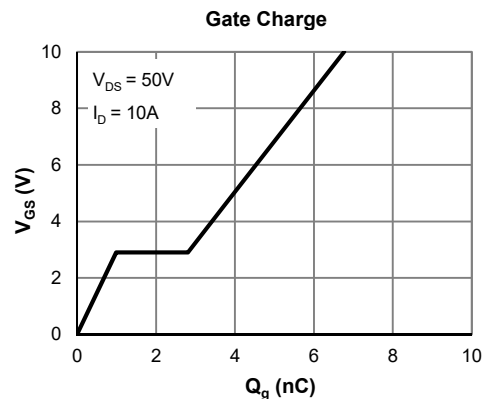
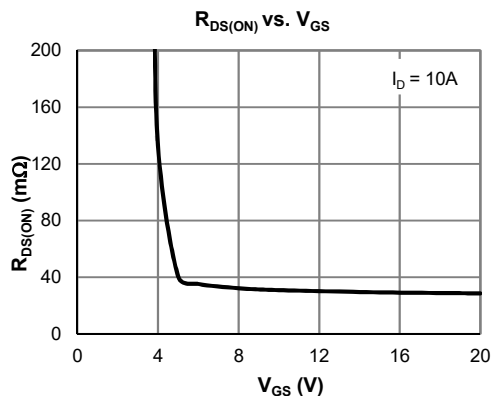



Electrical Characteristics (@ $T_J = 25^\circ\text{C}$ unless otherwise specified)

Parameter	Symbol	Conditions	Min.	Typ.	Max.	Unit
STATIC PARAMETERS						
Drain-Source Breakdown Voltage	$V_{(BR)DSS}$	$I_D = 250\mu\text{A}, V_{GS} = 0\text{V}$	100			V
Zero Gate Voltage Drain Current	I_{DSS}	$V_{DS} = 80\text{V}, V_{GS} = 0\text{V}$ $T_J = 55^\circ\text{C}$			1.0 5.0	μA
Gate-Body Leakage Current	I_{GSS}	$V_{DS} = 0\text{V}, V_{GS} = \pm 20\text{V}$			± 100	nA
Gate Threshold Voltage	$V_{GS(th)}$	$V_{DS} = V_{GS}, I_D = 250\mu\text{A}$	1.2	2.0	3.0	V
Static Drain-Source ON-Resistance	$R_{DS(on)}$	$V_{GS} = 10\text{V}, I_D = 10\text{A}$		29	36	$\text{m}\Omega$
		$V_{GS} = 4.5\text{V}, I_D = 6\text{A}$		39	50	$\text{m}\Omega$
Forward Transconductance	g_{FS}	$V_{DS} = 5\text{V}, I_D = 10\text{A}$		28		S
Diode Forward Voltage	V_{SD}	$I_S = 1\text{A}, V_{GS} = 0\text{V}$		0.70	1.0	V
Diode Continuous Current	I_S	$T_C = 25^\circ\text{C}$			24	A

DYNAMIC PARAMETERS ⁽⁵⁾						
Input Capacitance	C_{iss}	$V_{GS} = 0\text{V}, V_{DS} = 50\text{V}, f = 1\text{MHz}$		363		pF
Output Capacitance	C_{oss}			85		pF
Reverse Transfer Capacitance	C_{rss}			3.0		pF
Gate Resistance	R_g	$V_{GS} = 0\text{V}, V_{DS} = 0\text{V}, f = 1\text{MHz}$		2.6		Ω

SWITCHING PARAMETERS ⁽⁵⁾						
Total Gate Charge (@ $V_{GS} = 10\text{V}$)	Q_g	$V_{GS} = 0 \text{ to } 10\text{V}$ $V_{DS} = 50\text{V}, I_D = 10\text{A}$		6.8		nC
Total Gate Charge (@ $V_{GS} = 4.5\text{V}$)	Q_g			3.7		nC
Gate Source Charge	Q_{gs}			1.0		nC
Gate Drain Charge	Q_{gd}			1.8		nC
Turn-On DelayTime	$t_{D(on)}$			4.9		ns
Turn-On Rise Time	t_r	$V_{GS} = 10\text{V}, V_{DS} = 50\text{V}$ $R_L = 5.0\Omega, R_{GEN} = 6\Omega$		16.6		ns
Turn-Off DelayTime	$t_{D(off)}$			11.2		ns
Turn-Off Fall Time	t_f			4.9		ns
Body Diode Reverse Recovery Time	t_{rr}	$I_F = 10\text{A}, dI_F/dt = 100\text{A}/\mu\text{s}$		33		ns
Body Diode Reverse Recovery Charge	Q_{rr}	$I_F = 10\text{A}, dI_F/dt = 100\text{A}/\mu\text{s}$		45		nC

Thermal Performance

Parameter	Symbol	Typ.	Max.	Unit
Thermal Resistance, Junction-to-Ambient	$R_{\theta JA}$	48	58	$^\circ\text{C}/\text{W}$
Thermal Resistance, Junction-to-Case	$R_{\theta JC}$	4.0	5.2	$^\circ\text{C}/\text{W}$

Notes:

1. Computed continuous current assumes the condition of T_{J_Max} while the actual continuous current depends on the thermal & electro-mechanical application board design.
2. This single-pulse measurement was taken under $T_{J_Max} = 150^\circ\text{C}$.
3. This single-pulse measurement was taken under the following condition [$L = 100\mu\text{H}, V_{GS} = 10\text{V}, V_{DS} = 50\text{V}$] while its value is limited by $T_{J_Max} = 150^\circ\text{C}$.
4. The power dissipation P_D is based on $T_{J_Max} = 150^\circ\text{C}$.
5. This value is guaranteed by design hence it is not included in the production test.

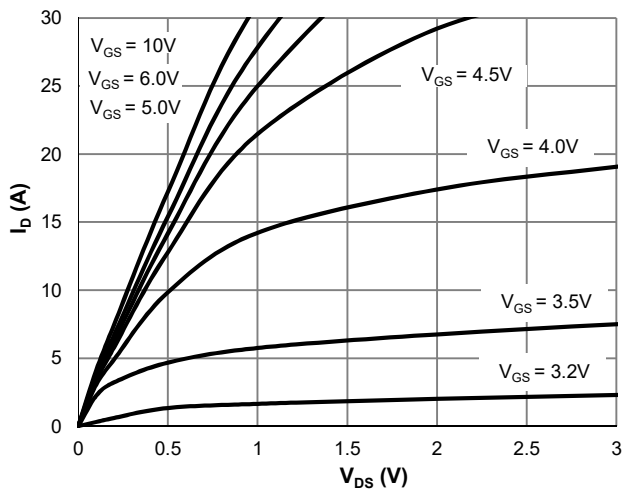
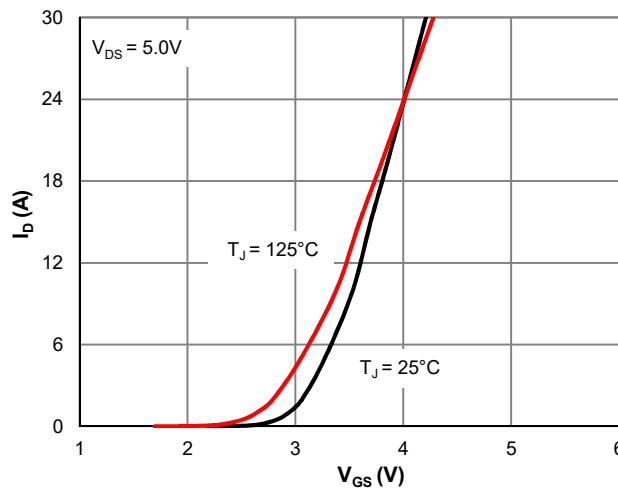
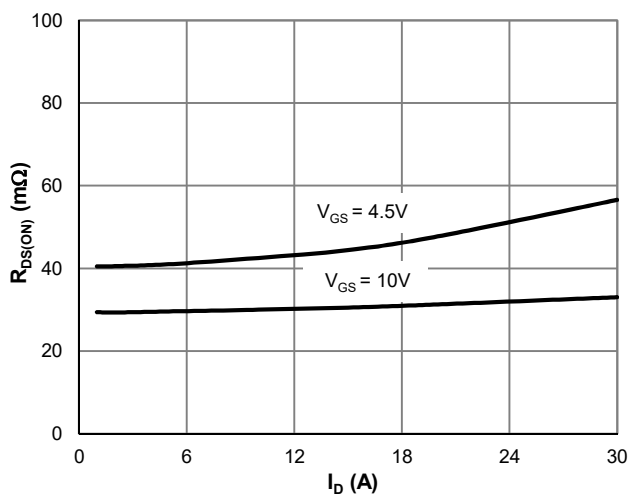
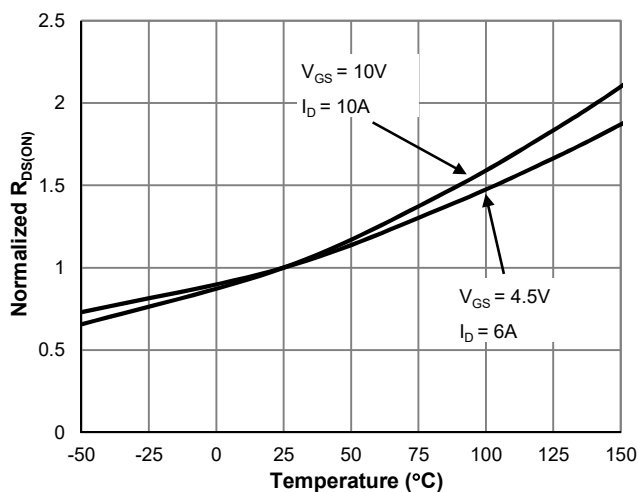
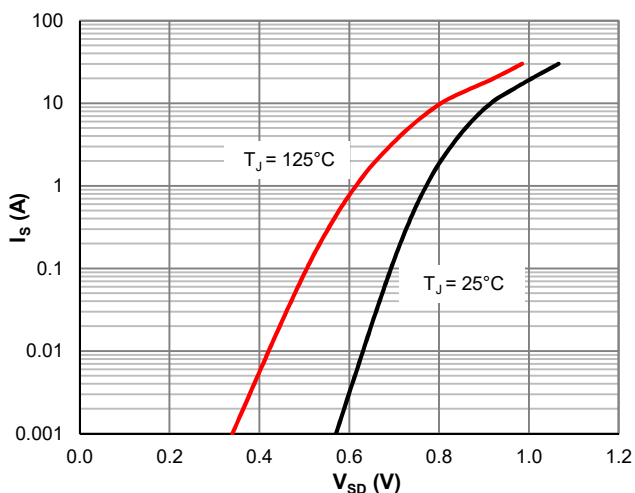
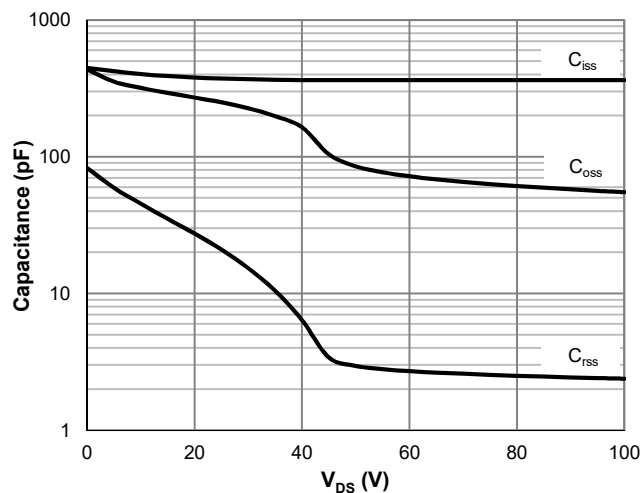
Typical Electrical & Thermal Characteristics

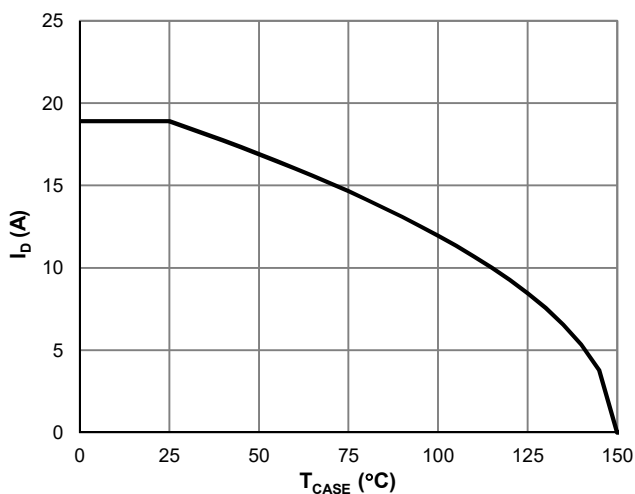
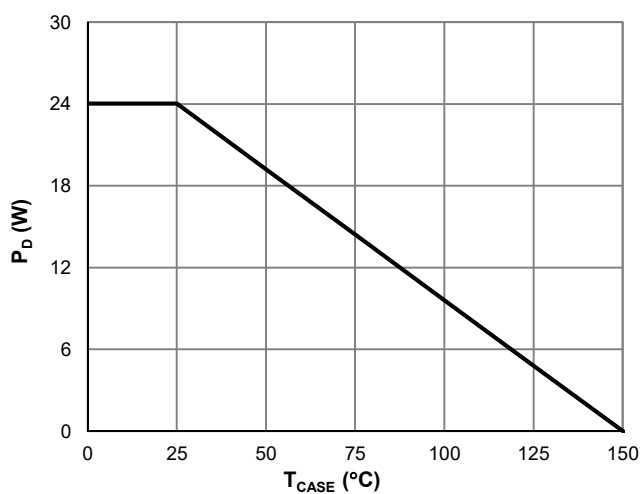
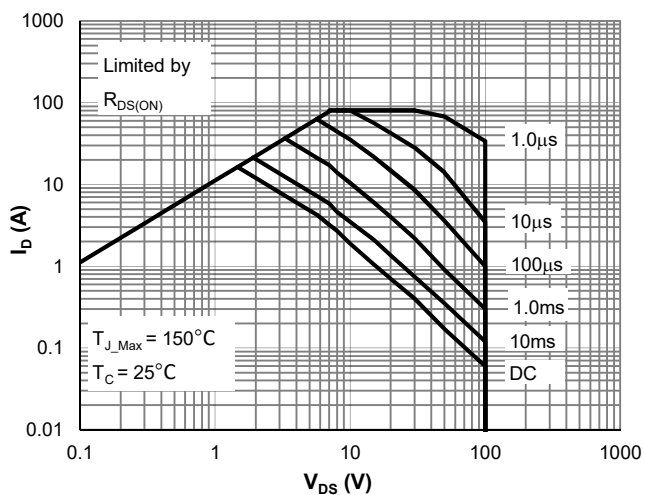
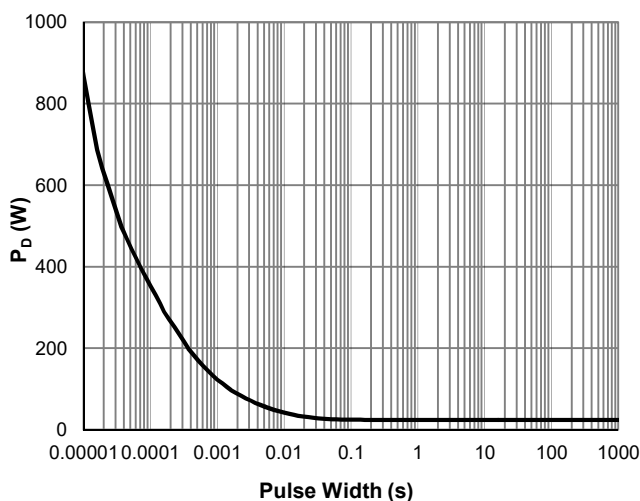
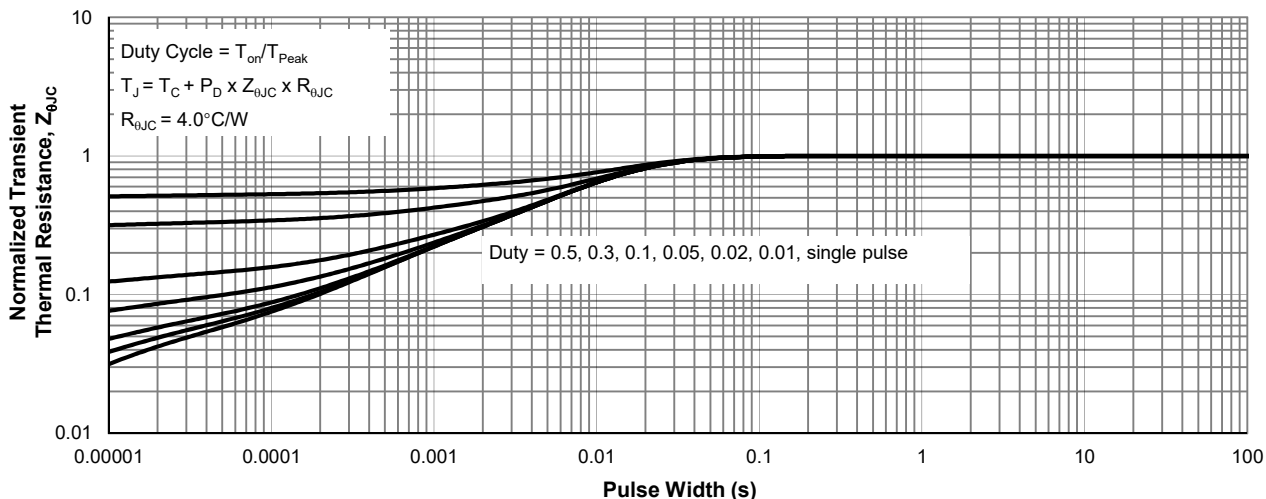
Figure 1: Saturation Characteristics

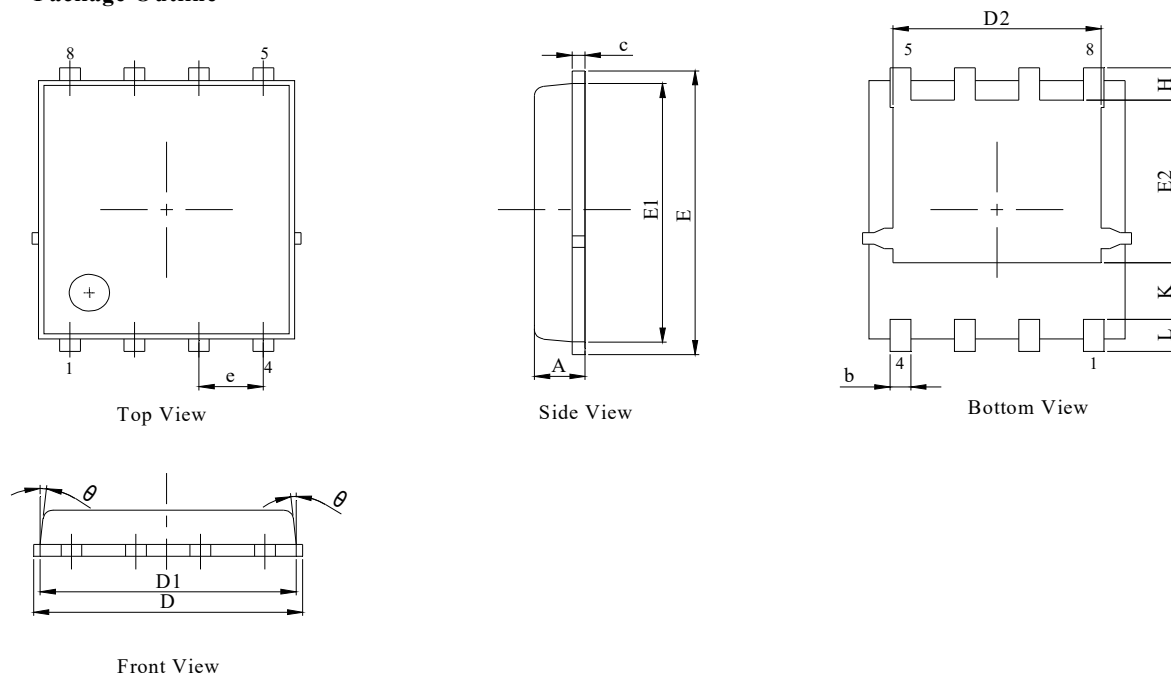
Figure 2: Transfer Characteristics

Figure 3: $R_{DS(ON)}$ vs. Drain Current

Figure 4: $R_{DS(ON)}$ vs. Junction Temperature

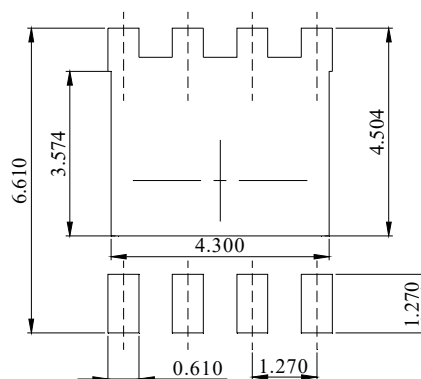
Figure 5: Body-Diode Characteristics

Figure 6: Capacitance Characteristics

Typical Electrical & Thermal Characteristics

Figure 7: Current De-rating

Figure 8: Power De-rating

Figure 9: Maximum Safe Operating Area

Figure 10: Single Pulse Power Rating, Junction-to-Case

Figure 11: Normalized Maximum Transient Thermal Impedance

PDFN5x6-8L Package Information
Package Outline

NOTES:

1. Dimension and tolerance per ASME Y14.5M, 1994.
2. All dimensions in millimeter (angle in degree).
3. Dimensions D1 and E1 do not include mold flash protrusions or gate burrs.

DIM.	MILLIMETER		
	MIN.	NOM.	MAX.
A	0.90	1.00	1.10
b	0.31	0.41	0.51
c	0.20	0.25	0.30
D	5.00	5.20	5.40
D1	4.95	5.05	5.15
D2	4.00	4.10	4.20
E	6.05	6.15	6.25
E1	5.50	5.60	5.70
E2	3.42	3.53	3.63
e	1.27BSC		
H	0.60	0.70	0.80
L	0.50	0.70	0.80
K	1.23 REF		
θ	-	-	10°

Recommended Soldering Footprint

DIMENSIONS: MILLIMETERS