

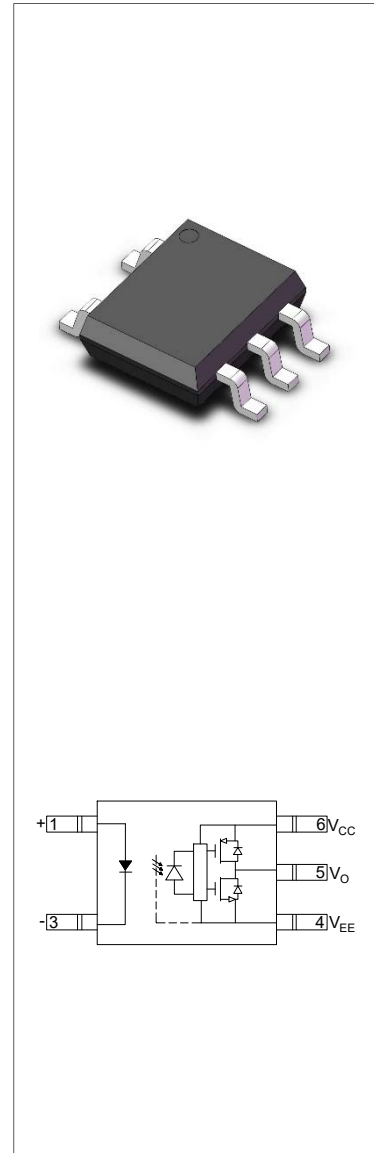

DESCRIPTION:

The products are gate driver opto-couplers in the SOP5 package. The device consists of an infrared LED optically coupled to an integrated high-gain, high-speed photodetector IC chip. It provides guaranteed performance and specifications at temperature up to 110°C. It is physically smaller and compliant with international safety standards for reinforced insulation. It thus provides a smaller footprint solution for applications that require safety standard certification. An internal noise shield provides a guaranteed common-mode transient immunity of ± 20 kV/ μ s. It is ideal for small class IGBT and power MOSFET gate drive. The products are widely used in industrial inverters, IGBT gate drivers, MOSFET gate drivers, induction cooktop and home appliances.



MAIN FEATURES

- High isolation 3750 VRMS
- Buffer logic type
- Operating temperature range -40°C to 110°C
- REACH & RoHS compliance
- HBM: H3A; MM: M4; CDM: C3
- CQC approved
- VDE approved
- UL approved

Truth Table

LED	V _{CC} -V _{EE} (Positive Going)	V _{CC} -V _{EE} (Negative Going)	Output
OFF	0-30V	0-30V	Low
ON	0-6.9V	0-5.9V	Low
ON	6.9V-8.7V	5.9V-7.5V	TRANSITION
ON	8.7V-30V	7.5V-30V	HIGHT

ABSOLUTE MAXIMUM RATINGS (Temperature=25°C)

Parameter		Symbol	Value	Unit
LED	Forward Current	I_F	50	mA
	Peak Forward Current	I_{FP}	1 ^①	A
	Reverse Voltage	V_R	6	V
	Power Dissipation	P_D	100	mW
Detector	Output Voltage	V_O	35	V
	Supply Voltage	V_{CC}	35	V
	Power Dissipation	P_C	400	mW
Isolation Voltage		V_{iso}	3750 ^②	Vrms
Operating Temperature		T_{opr}	-40~110	°C
Junction Temperature		T_j	125	°C
Storage Temperature		T_{stg}	-55~125	°C
Total Power Dissipation		P_{tot}	500	mW
Soldering Temperature		T_{sol}	260	°C

NOTE1 : 100µs pulse, 100Hz frequency

NOTE2 : AC for 1minute, R.H.=40~60%

ELECTRICAL CHARACTERISTICS (Temperature=25°C)

Parameter		Symbol	Condition	Min.	Typ.	Max.	Unit
Input	Forward Voltage	V_F	$I_F=10mA$	-	1.35	1.6	V
	Reverse Current	I_R	$V_R=6V$	-	-	1	µA
	Terminal Capacitance	C_t	$V=0, f=1MHz$	-	60	-	pF
Output	Peak High-level Output Current	I_{OPH}	$V_O=V_{CC}-4V,$ Pulse width≤50µs	-1	-	-	A
			$V_O=V_{CC}-15V,$ Pulse width≤10µs	-3	-	-	A
	Peak Low-level Output Current	I_{OPL}	$V_O=V_{EE}+2.5V,$ Pulse width≤50µs	1	-	-	A
			$V_O=V_{EE}+15V,$ Pulse width≤10µs	3	-	-	A
	High Level Supply Current	I_{CCH}	$I_F=10mA$ $V_{CC}=30V,$ $V_O=Open,$	-	1.2	2	mA
	Low Level Supply Current	I_{CCL}	$I_F=0mA,$ $V_{CC}=30V,$ $V_O=Open,$	-	1.1	2	mA

High Level Output Voltage	V_{OH}	$I_F=5mA,$ $V_{CC}=10V,$ $I_O=-100mA$	6	8.4	-	V
Low Level Output Voltage	V_{OL}	$V_F=0.8V,$ $V_{CC}=10V,$ $I_O=100mA$	-	0.3	1	V
Threshold Input Current	I_{FLH}	$V_{CC}=15V,$ $V_O>1V$	-	1.2	5	mA
Threshold Input Voltage	V_{FHL}	$V_{CC}=15V,$ $V_O<1V$	0.8	-	-	V
Supply Voltage	V_{CC}	-	10	-	30	V
UVLO Threshold	VUVLO+	$V_O>2.5V,$ $I_F=5mA$	7.5	8.7	9.5	V
	VUVLO-	$V_O<2.5V,$ $I_F=5mA$	7.5	8.4	9.5	V

SWITCHING SPECIFICATION

Parameter	Symbol	Condition	Min.	Typ.	Max.	Unit
Propagation Delay Time to High Output Level	$t_{PLH}^{①}$	$R_g=47\Omega$, $C_g=3nF$, $I_F=0\rightarrow 5mA$, $V_{CC}=30V$	30	-	500	ns
Propagation Delay Time to Low Output Level	$t_{PHL}^{①}$	$R_g=47\Omega$, $C_g=3nF$, $I_F=5\rightarrow 0mA$, $V_{CC}=30V$	30	-	500	
Propagation Delay Difference Between Any Two Parts	$t_{PHL} - t_{PLH}^{①}$	$R_g=47\Omega$, $C_g=3nF$, $I_F=0\leftarrow\rightarrow 5mA$, $V_{CC}=30V$	-	-	350	
Output Rise Time (10 to 90%)	$t_r^{①}$	$R_g=47\Omega$, $C_g=3nF$, $I_F=0\rightarrow 5mA$, $V_{CC}=30V$	-	50	-	
Output Fall Time (90 to 10%)	$t_f^{①}$	$R_g=47\Omega$, $C_g=3nF$, $I_F=5\rightarrow 0mA$, $V_{CC}=30V$	-	50	-	
Common Mode Transient Immunity at High Level Output	$ CM_H ^{②}$	$I_F=5mA$ $V_{CC}=30V$, $T_a=25^\circ C$, $V_O(\min)=26V$ $V_{CM}=1000V_{pp}$	± 35	-	-	
Common Mode Transient Immunity at Low Level Output	$ CM_L ^{③}$	$I_F=0mA$ $V_{CC}=30V$, $T_a=25^\circ C$, $V_O(\max)=1V$ $V_{CM}=1000V_{pp}$	± 35	-	-	kV/ μs

All Typical values at $T_a=25^\circ C$

Note1: Input signal ($f=25kHz$, $duty=50\%$, $t_r=t_f=5ns$ or less). C_L is less than 15 pF which includes probe and stray wiring capacitance.

Note2: CM_H is the maximum rate of fall of the common mode voltage that can be sustained with the output voltage in the logic high state ($V_O > 26V$).

Note3: CM_L is the maximum rate of rise of the common mode voltage that can be sustained with the output voltage in the logic low state ($V_O < 1V$).

Recommended Operating Conditions^{①②}

Characteristics	Symbol	Min.	Typ.	Max.	Unit
Input On-state Current	$I_{F(ON)}$ ^③	6.5	-	10	mA
Input Off-state Voltage	$V_{F(OFF)}$	0	-	0.8	V
Supply Voltage	V_{CC} ^④	10	-	30	V
Operating Frequency	f ^⑤	-	-	25	kHz

Note1: The recommended operating conditions are given as a design guide necessary to obtain the intended performance of the device. Each parameter is an independent value. When creating a system design using this device, the electrical characteristics specified in this datasheet should also be considered.

Note2: A ceramic capacitor(0.1μF) should be connected between pin 6 (V_{CC}) and pin 4 (GND) to stabilize the operation of a high-gain linear amplifier. Otherwise, this photocoupler may not switch properly. The bypass capacitor should be placed within 1 cm of each pin.

Note3: The rise and fall times of the input on-current should be less than 0.5 μs.

Note4: If the rising slope of the supply voltage (V_{CC}) for the detector is steep, stable operation of the internal circuits cannot be guaranteed. Be sure to set 3 V/μs or less for a rising slope of the V_{CC} .

Note5: Denotes the operating range, not the recommended operating condition.

ORDERING INFORMATION

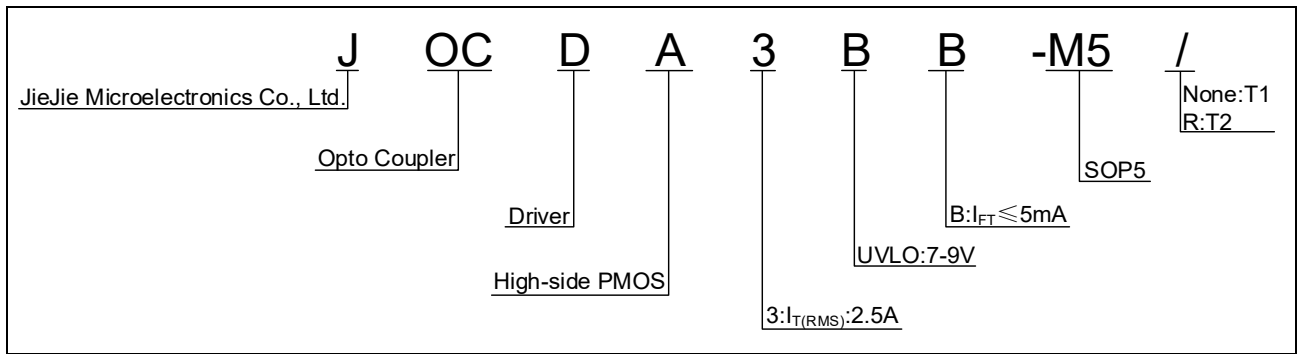

Packing Quantity	
Option	Quantity
None/R	3000 Units/Reel

MARKING

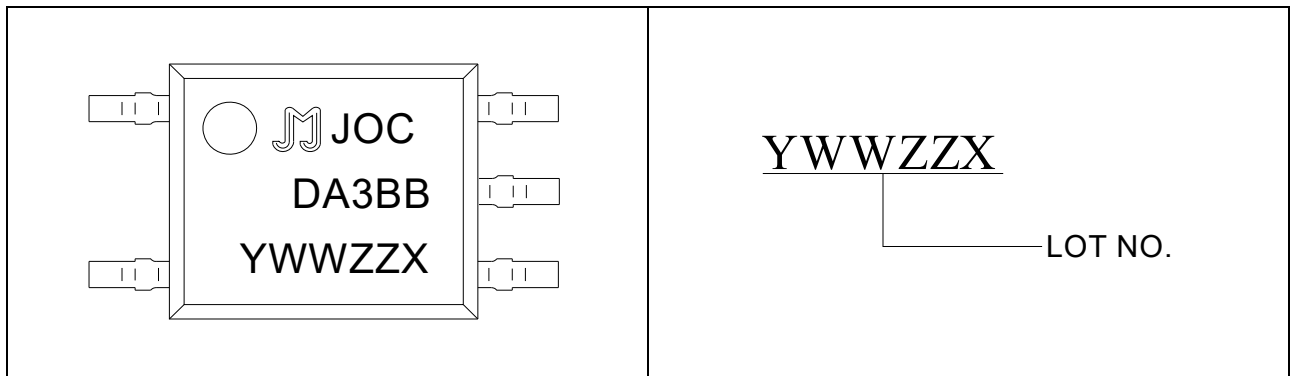

Characteristics Curves

FIG.1: Forward Current vs. Forward Voltage

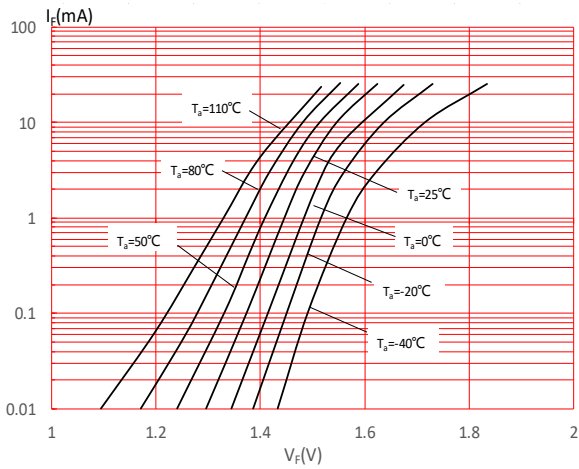

FIG.2: Max. Allowable LED Forward Current vs. Ambient Temperature

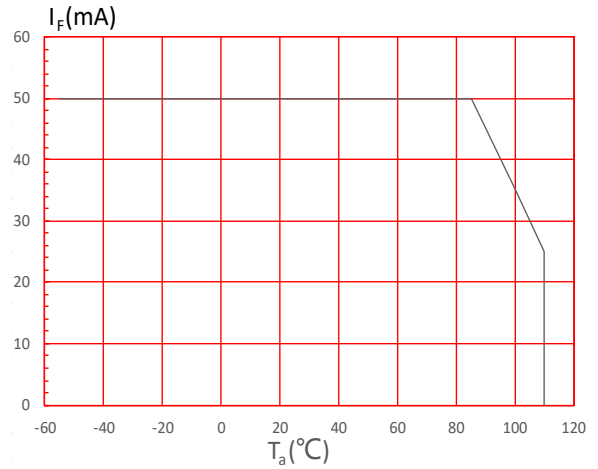

FIG.3: Collector Power Dissipation vs. Ambient Temperature

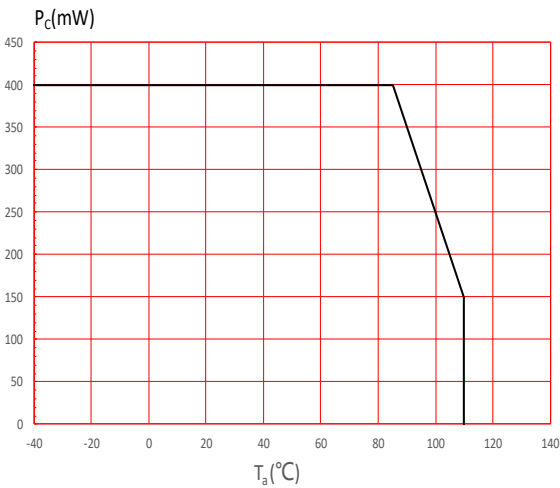

FIG.4: Threshold Input Current vs. Ambient Temperature

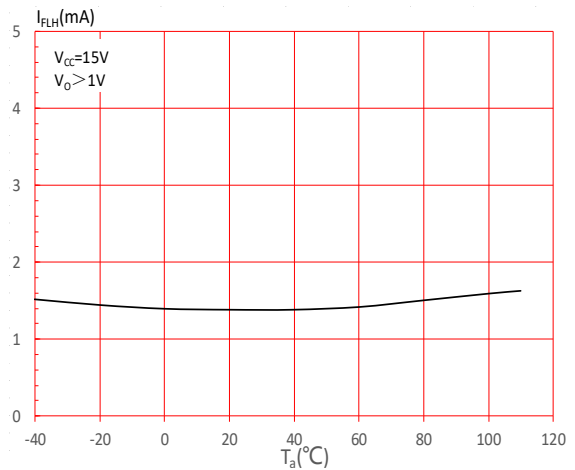

FIG.5: Low-level Supply Current vs. Ambient Temperature

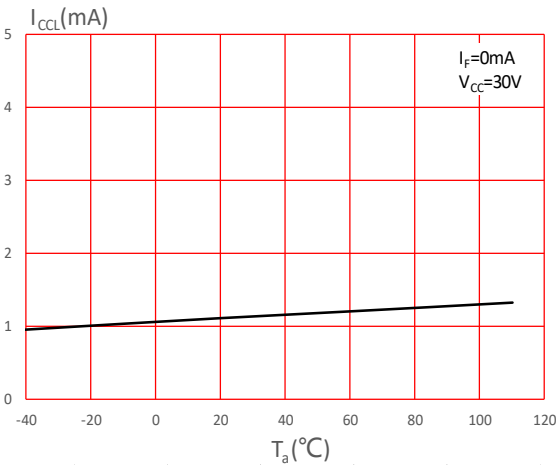

FIG.6: High-level Supply Current vs. Ambient Temperature

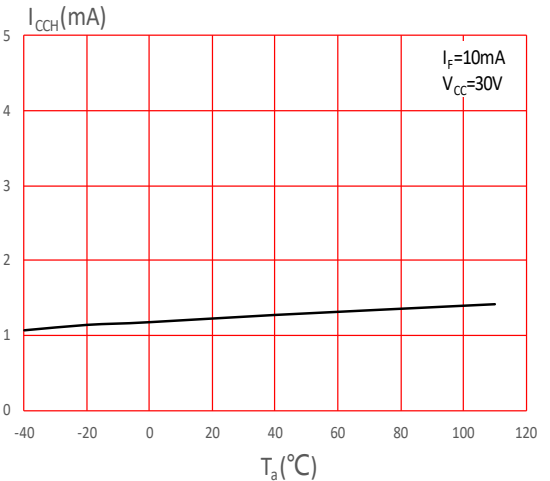

FIG.7: Low-level Output Voltage vs. Ambient Temperature

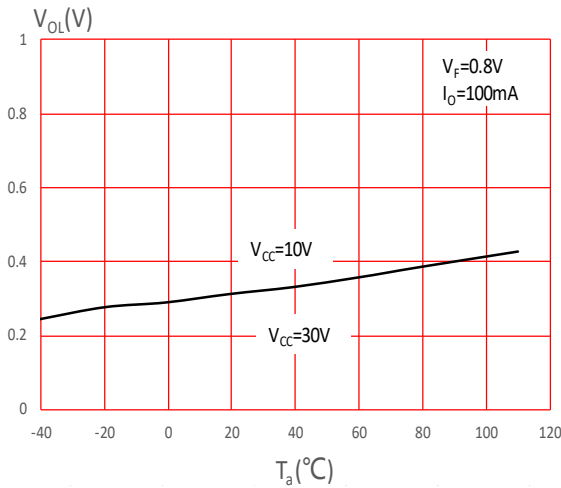

FIG.8: High-level Output Voltage vs. Ambient Temperature

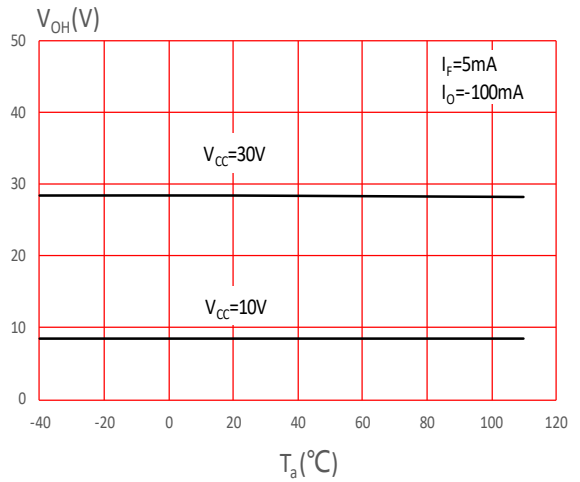

FIG.9: Low-level Output Voltage vs. Peak Low-level Output Current

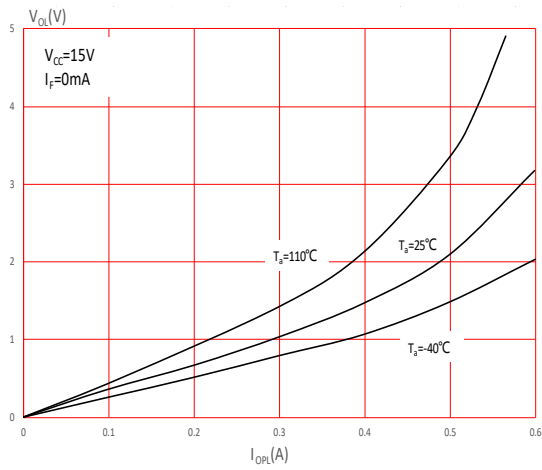

FIG.10: High-level Output Voltage Drop vs. Peak High-level Output Current

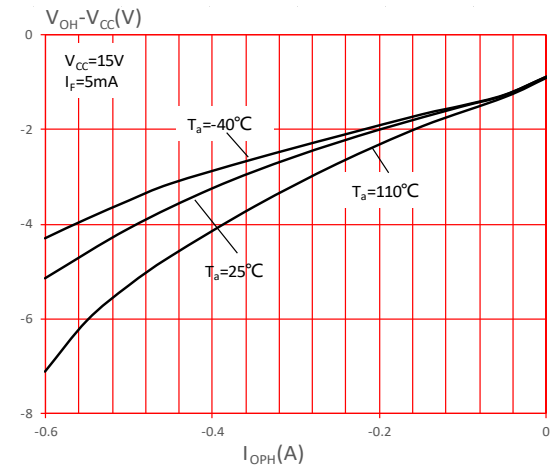

FIG.11: Propagation Delay Time, Pulse Width Distortion vs. Ambient Temperature

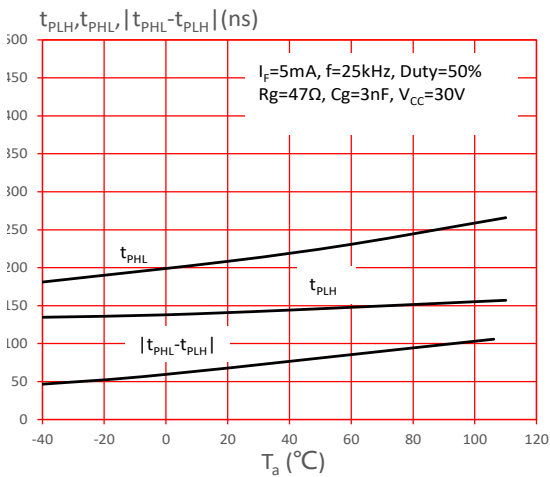

FIG.12: Propagation Delay Time, Pulse Width Distortion vs. Forward Current

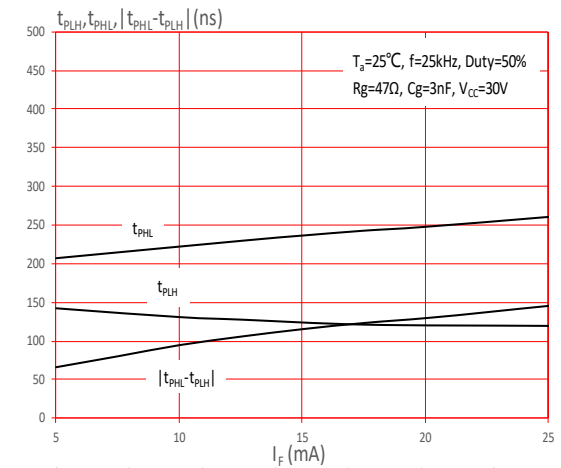
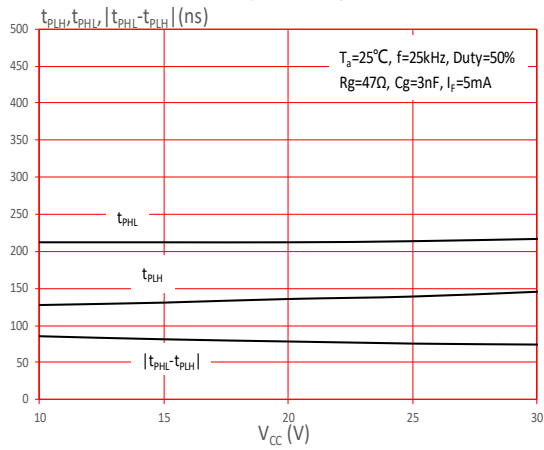

FIG.13: Propagation Delay Time,Pulse Width Distortion vs. Supply Voltage



Test Circuits

FIG.14: Switching Time Test Circuit and Waveform

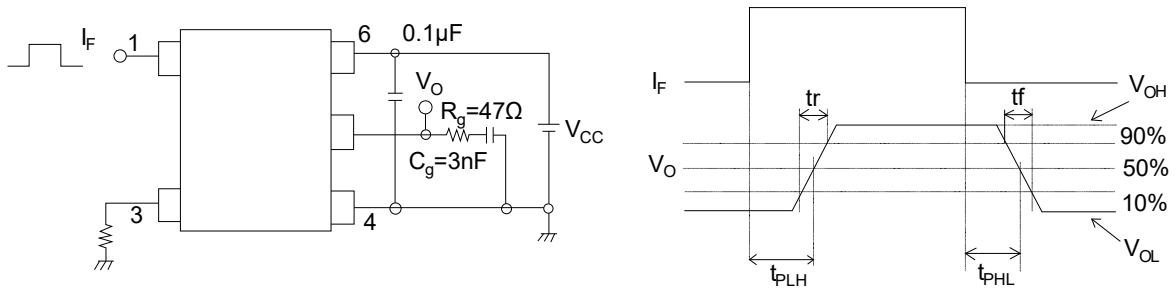
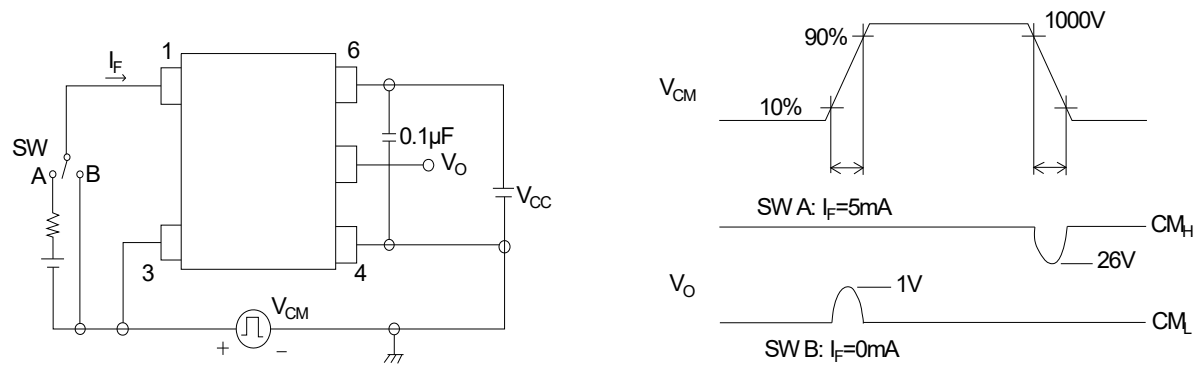
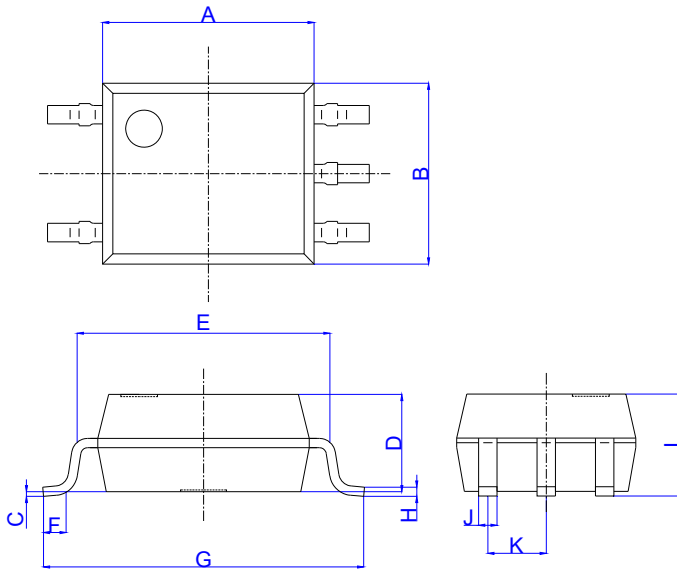

FIG.15: Common-Mode Transient Immunity Test Circuit and Waveform



Package Dimension (Unit: mm)



Ref.	Dimensions					
	Millimeters			Inches		
	Min.	Typ.	Max.	Min.	Typ.	Max.
A	4.40		4.80	0.173		0.189
B	3.60		4.20	0.142		0.165
C	0.00		0.20	0.000		0.008
D	1.90		2.30	0.075		0.091
E	5.00		5.60	0.197		0.220
F	0.34		0.94	0.013		0.037
G	6.70		7.30	0.264		0.287
H	0.10		0.30	0.004		0.012
I	2.00		2.40	0.079		0.094
J	0.25		0.55	0.010		0.022
K	1.02		1.52	0.040		0.060

RECOMMENDED SOLDER MASK (Dimensions in mm unless otherwise stated)

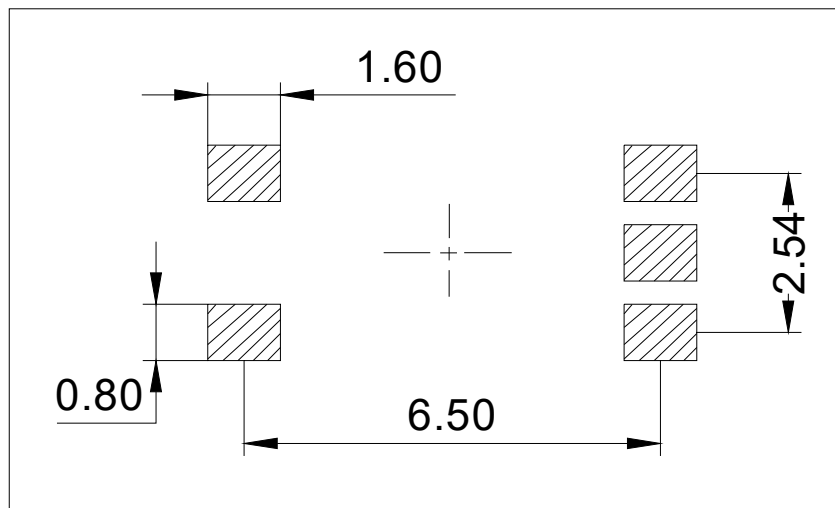

CARRIER TAPE SPECIFICATIONS (Dimensions in mm unless otherwise stated)

Option None

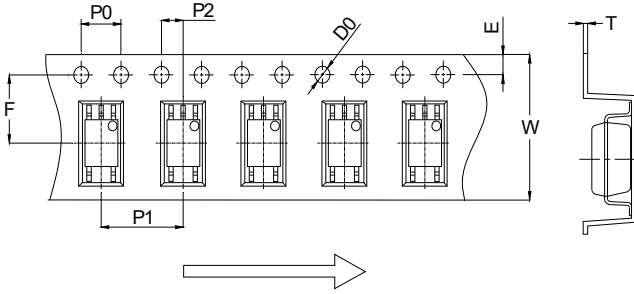

Ref.	Dimensions					
	Millimeters			Inches		
	Min.	Typ.	Max.	Min.	Typ.	Max.
D0		1.50	1.60		0.059	0.063
P0	3.90	4.00	4.10	0.154	0.157	0.161
P1	7.90	8.00	8.10	0.311	0.315	0.319
P2	1.90	2.00	2.10	0.075	0.079	0.083
E	1.65	1.75	1.85	0.065	0.069	0.073
F	4.40	4.50	4.60	0.173	0.177	0.181
T	0.25	0.30	0.35	0.010	0.012	0.014
W	11.90	12.00	12.30	0.469	0.472	0.484

Option R

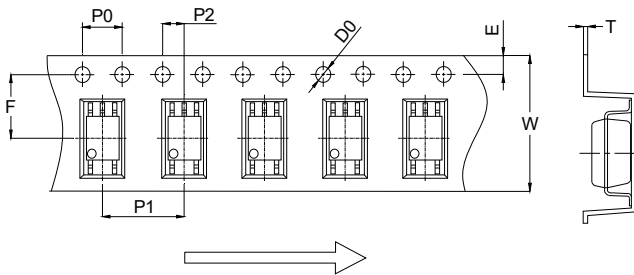

Ref.	Dimensions					
	Millimeters			Inches		
	Min.	Typ.	Max.	Min.	Typ.	Max.
D0		1.50	1.60		0.059	0.063
P0	3.90	4.00	4.10	0.154	0.157	0.161
P1	7.90	8.00	8.10	0.311	0.315	0.319
P2	1.90	2.00	2.10	0.075	0.079	0.083
E	1.65	1.75	1.85	0.065	0.069	0.073
F	4.40	4.50	4.60	0.173	0.177	0.181
T	0.25	0.30	0.35	0.010	0.012	0.014
W	11.90	12.00	12.30	0.469	0.472	0.484

REFLOW INFORMATION

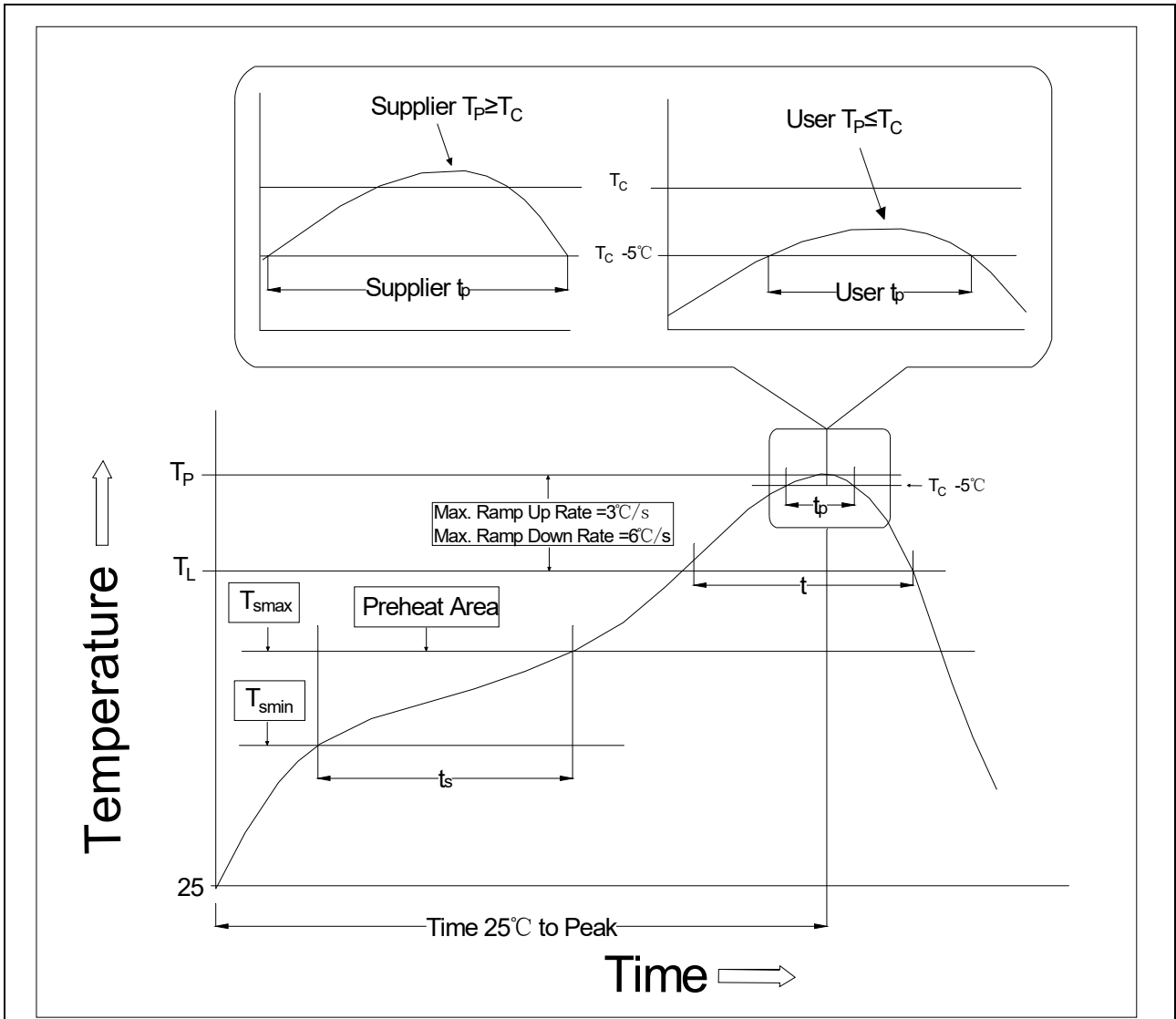

Profile Feature	Sn-Pb Assembly Profile	Pb-Free Assembly Profile
Temperature Min. (T _{smin})	100	150°C
Temperature Max. (T _{smax})	150	200°C
Time (t _s) from (T _{smin} to T _{smax})	60-120 seconds	60-120 seconds
Ramp-up Rate (t _L to t _P)	3°C/second max.	3°C/second max.
Liquidus Temperature (T _L)	183°C	217°C
Time (t _L) Maintained Above (T _L)	60-150 seconds	60-150 seconds
Peak Body Package Temperature	235°C+0°C/-5°C	260°C+0°C/-5°C
Time (t _P) within 5°C of 260°C	20 seconds	30 seconds
Ramp-down Rate (T _P to T _L)	6°C/second max.	6°C/second max.
Time 25°C to Peak Temperature	6 minutes max.	8 minutes max.

Note:

1. Reflow soldering is recommended at the temperatures and times shown, no more than three times.
2. Avoid direct contact between the epoxy body and any tools or surfaces exceeding its maximum storage temperature.
3. Application of pressure on the epoxy body is prohibited at elevated temperatures. In specific scenarios, any applied force must not exceed 2.5N.
4. Ensure the component has cooled to ambient temperature before proceeding with any subsequent manufacturing steps.
5. The component has a shelf life of one year when stored under standard conditions.
6. Recommend storage Temp.: 0~40°C;
Recommend storage humidity: <60%;
MSL level: MSL 1

Information furnished in this document is believed to be accurate and reliable. However, Jiangsu JieJie Microelectronics Co., Ltd. assumes no responsibility for the consequences of use without consideration for such information nor use beyond it. Information mentioned in this document is subject to change without notice, apart from that when an agreement is signed, Jiangsu JieJie complies with the agreement.

Products and information provided in this document have no infringement of patents. Jiangsu JieJie assumes no responsibility for any infringement of other rights of third parties which may result from the use of such products and information. This document supersedes and replaces all information previously supplied.

 is a registered trademark of Jiangsu JieJie Microelectronics Co., Ltd.

Copyright © 2026 Jiangsu JieJie Microelectronics Co., Ltd. All rights reserved.