

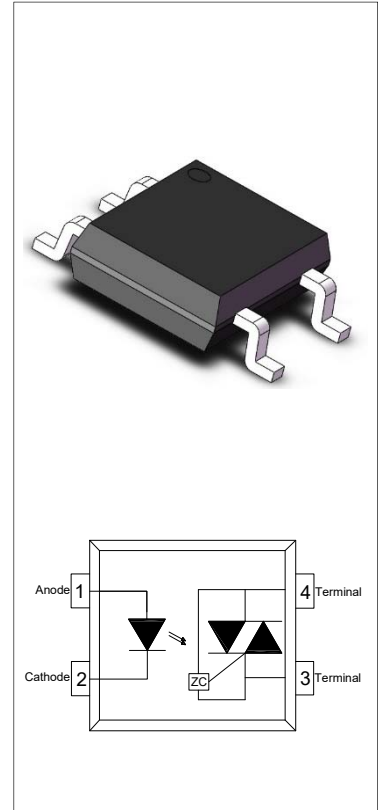

### DESCRIPTION:

The products are 4-pin thyristor opto-couplers. The device combines an AlGaAs infrared emitting diode as the emitter which is optically coupled to a monolithic silicon zero-crossing photo triac in a plastic SOP4 package. The products are widely used in solenoid/valve controls, lighting controls, motor controls, temperature controls, static AC power switches, solid state relays, interfacing microprocessors up to 265 V<sub>AC</sub> peripherals.



### MAIN FEATURES

- High isolation 3750 VRMS
- DC input with zero-crossing photo triac output
- Operating temperature range -55 °C to 110 °C
- REACH & RoHS compliance
- HBM: H3A ; MM: M4; CDM: C3
- CQC approved
- VDE approved
- UL approved

### ABSOLUTE MAXIMUM RATINGS (Temperature=25°C)

Parameter		Symbol	Value	Unit	
Input	Forward Current	I <sub>F</sub>	50	mA	
	Peak Forward Current	I <sub>FP</sub>	1 <sup>①</sup>	A	
	Reverse Voltage	V <sub>R</sub>	6	V	
	Power Dissipation	P <sub>D</sub>	75	mW	
Output	Off-state Output Terminal Voltage	V <sub>OFF</sub>	JOCSZ21X	600	V
			JOCSZ31X	800	
	Peak On-state Current (100µs pulse, 120 pps)	I <sub>TP</sub>	2	A	
	On-state RMS Current	I <sub>T(RMS)</sub>	100	mA	
	Peak Repetitive Surge Current (P <sub>W</sub> =10 ms)	I <sub>TSM</sub>	1.2	A	
Output Power Dissipation		P <sub>O</sub>	250	mW	
Total Power Dissipation		P <sub>tot</sub>	325	mW	
Isolation Voltage		V <sub>iso</sub>	3750 <sup>②</sup>	Vrms	

Operating Temperature	$T_{opr}$	-55~110	°C
Junction Temperature	$T_j$	125	°C
Storage Temperature	$T_{stg}$	-55~125	°C
Soldering Temperature	$T_{sol}$	260	°C
Peak pulse voltage ( $T_j=25^{\circ}\text{C}$ ; non-repetitive,off-state)	$V_{pp}$	1	kV

NOTE1: 100μs pulse, 100Hz frequency

NOTE2: AC for 1minute, R.H.=40~60%

**ELECTRICAL CHARACTERISTICS** (Temperature=25°C)

Parameter		Symbol	Condition	Min.	Typ.	Max.	Unit
Input	Forward Voltage	$V_F$	$I_F=10\text{mA}$	-	1.2	1.5	V
	Reverse Current	$I_R$	$V_R=6\text{V}$	-	-	1	μA
	Input Capacitance	$C_{in}$	$V=0, f=1\text{kHz}$	-	10	-	pF
Output	Peak Off-state Current, Either Direction	$I_{OFF}$	$V_{OFF}=\text{Rated } V_{OFF}$ $I_F=0$	-	-	100 <sup>③</sup>	nA
	Peak On-state Voltage, Either Direction	$V_{TM}$	$I_{TM}=100\text{mA}$	-	1.8	2.5	V
	Critical Rate of Rise of Off-state voltage	dV/dt	$V_{PEAK}=\text{Rated } V_{PEAK}$ $I_F=0$	2000 <sup>④</sup>	-	-	V/μs
Transfer Characteristics	LED Trigger Current	JOCSZ21A JOCSZ31A	Terminal Voltage=3V $I_{TM}=100\text{mA}$	-	-	10	mA
		JOCSZ21B JOCSZ31B		-	-	5	
		JOCSZ21C JOCSZ31C		-	-	3	
	Holding Current	$I_H$	$I_{TM}=2\text{mA},$ $I_F=\text{Rated } I_{FT}$	-	500	-	μA
	Isolation Resistance	$R_{ISO}$	DC500V 40~60%R.H.	$10^{12}$	$10^{14}$	-	Ω
	Floating Capacitance	$C_{IO}$	$V=0,$ $f=1\text{MHz}$	-	5	-	pF
	Response Time	$t_{on}$	$V_D=6\text{V},$ $R_L=100\Omega,$ $I_F=20\text{mA}$	-	15	50	μs
Zero-Crossing Characteristics	Inhibit Voltage	$V_{IH}$	$I_F=\text{Rated } I_{FT}$	-	-	20	V
	Leakage in Inhibited State	$I_{OFF2}$	$I_F=\text{Rated } I_{FT}$ $V_{OFF}=\text{Rated } V_{OFF}$	-	-	5	mA

NOTE3: Test voltage must be applied within dV/dt ratings.

NOTE4: Refer to Fig.14 & Fig.15

**ORDERING INFORMATION**

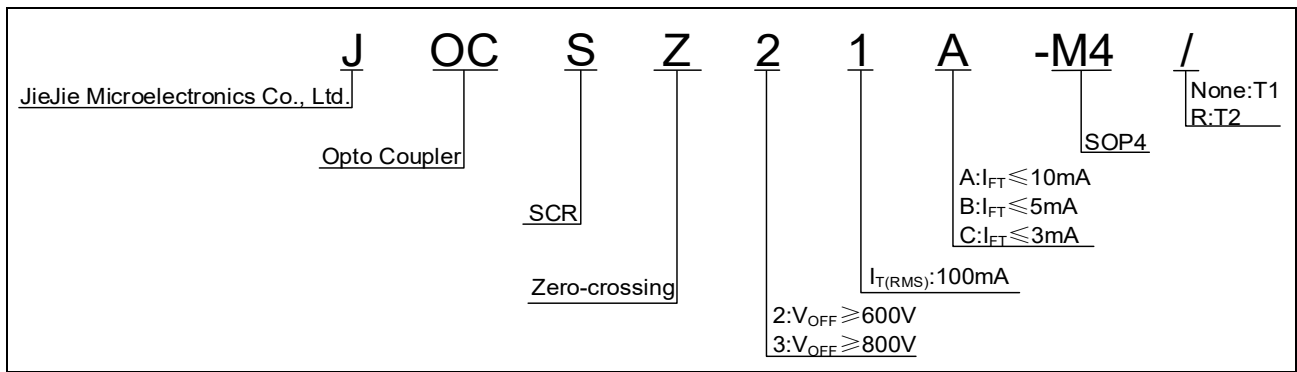

Packing Quantity	
Option	Quantity
None/R	3000 Units/Reel

**MARKING**

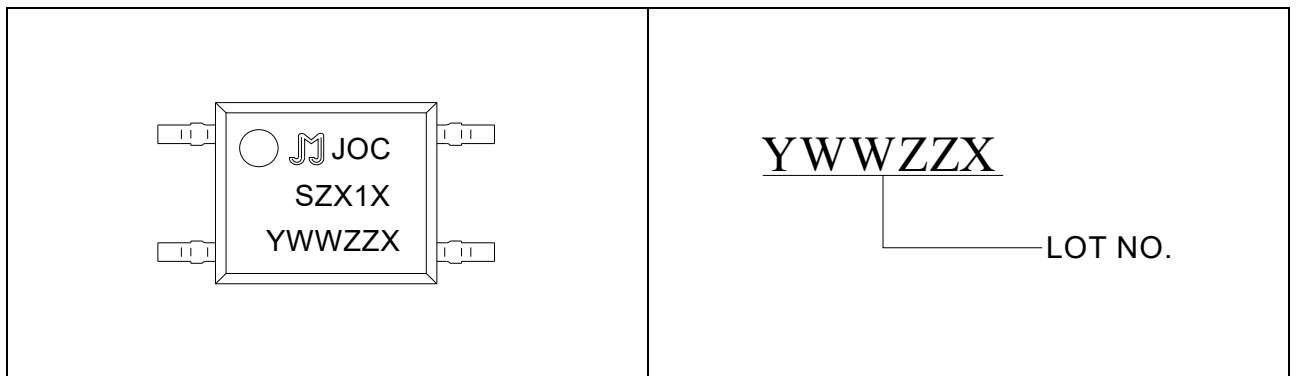

Characteristics Curves

FIG.1: Max. Allowable LED Forward Current vs. Ambient Temperature

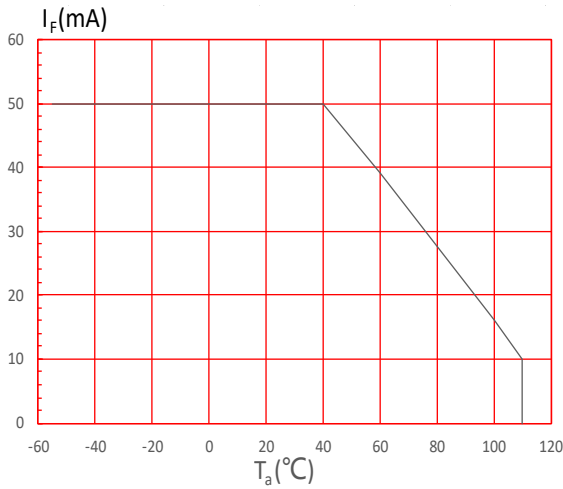

FIG.2: On-state Terminal Current vs. Ambient Temperature

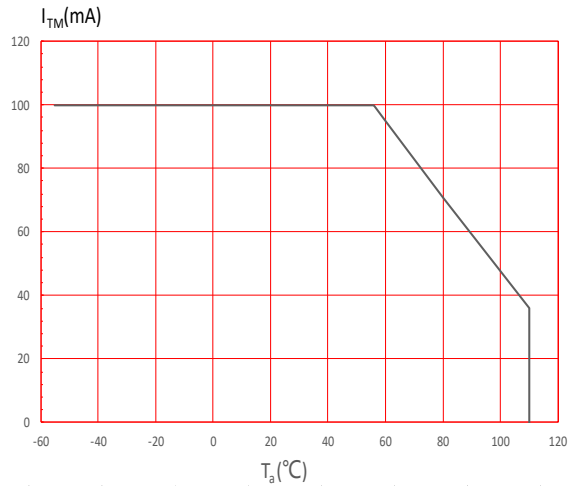

FIG.3: Forward Current vs. Forward Voltage

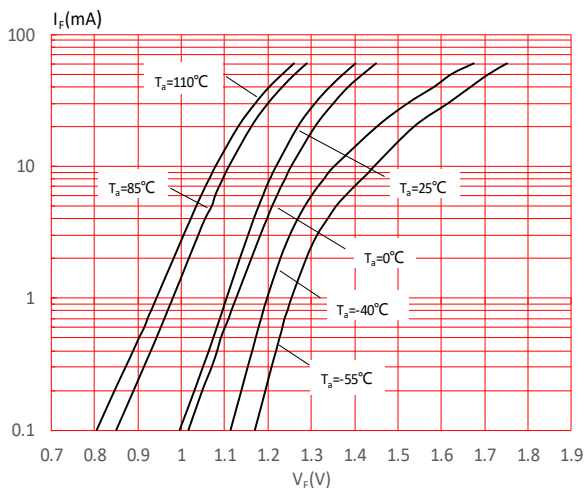

FIG.4: Normalized Off-state Terminal Current vs. Ambient Temperature

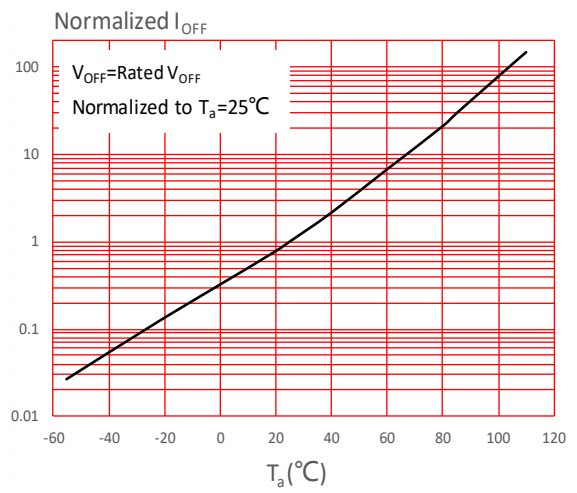

FIG.5: Normalized Off-state Terminal Voltage vs. Ambient Temperature

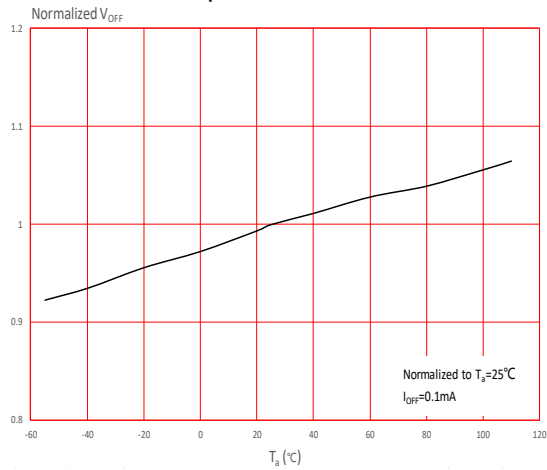
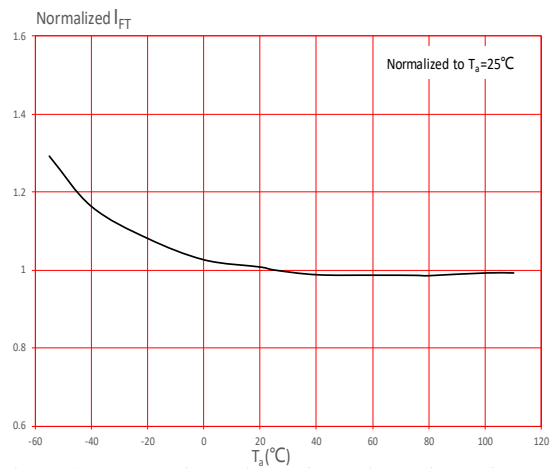
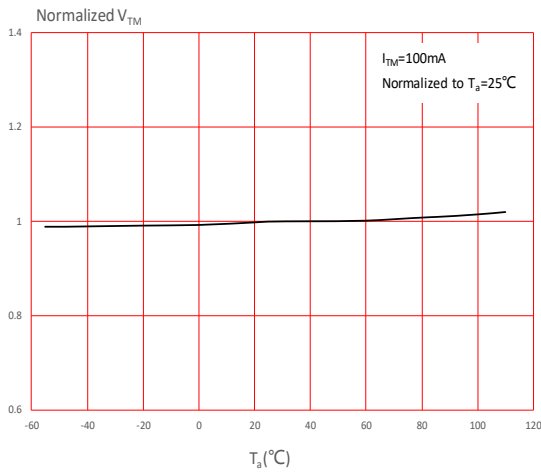

FIG.6: Normalized Trigger Current vs. Ambient Temperature



**FIG.7:** Normalized On-state Terminal Voltage vs. Ambient Temperature



**FIG.8:** On-state Terminal Voltage vs. On-state Terminal Current

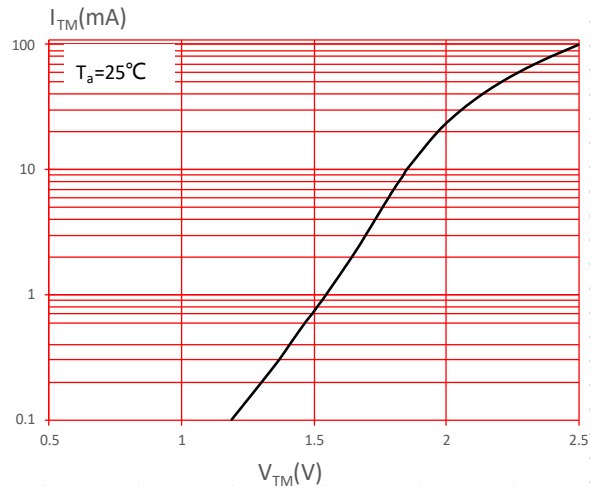

**FIG.9:** Normalized Holding Current vs. Ambient Temperature

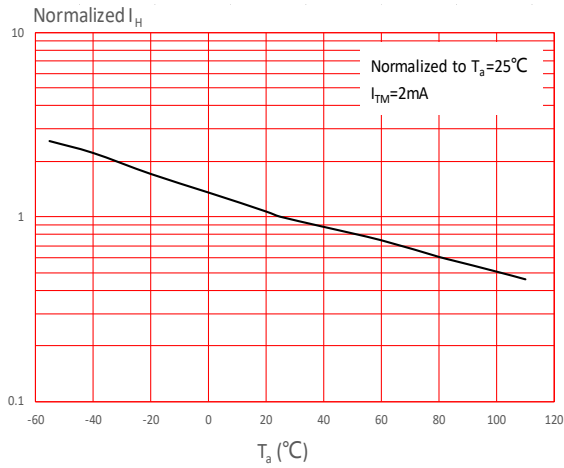

**FIG.10:** Normalized Leakage in Inhibit State vs. Ambient Temperature

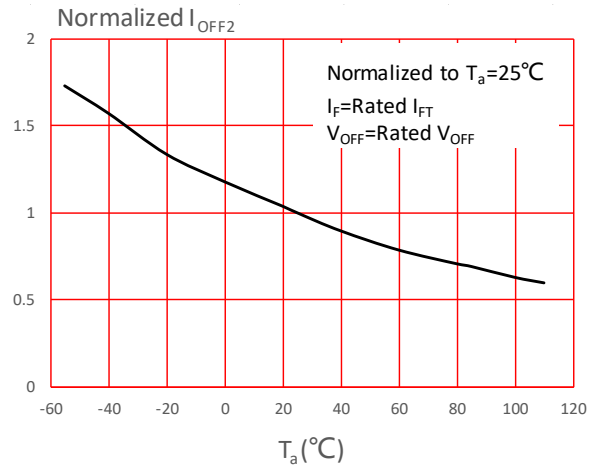

**FIG.11:** Normalized Inhibit Voltage vs. Ambient Temperature

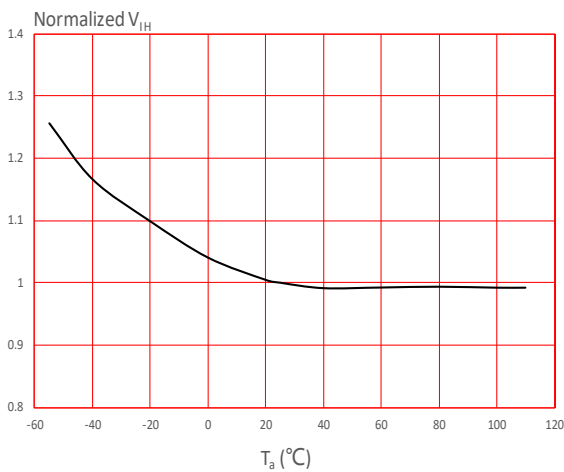

TEST CIRCUITS

FIG.12: Test Circuits of Turn On Time

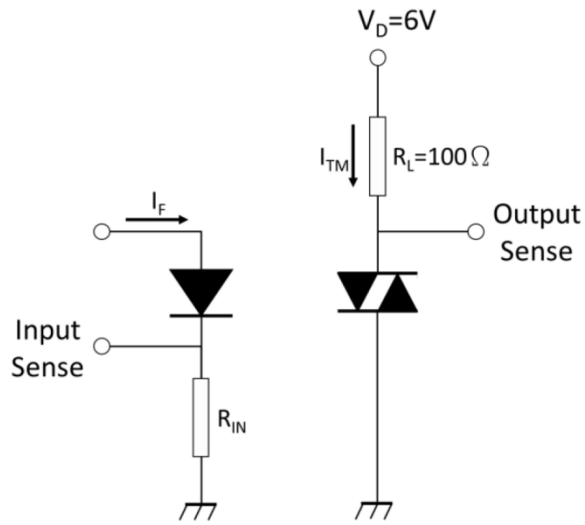

FIG.13: Waveforms of Turn On Time



Fig.14: Test Circuits of dV/dt

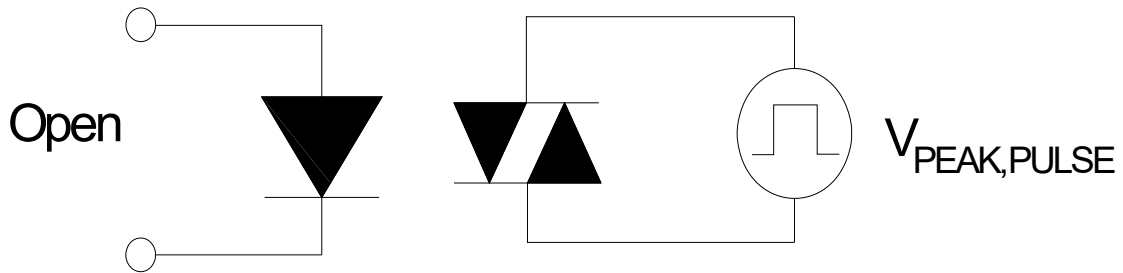

Fig.15: Waveforms of dV/dt

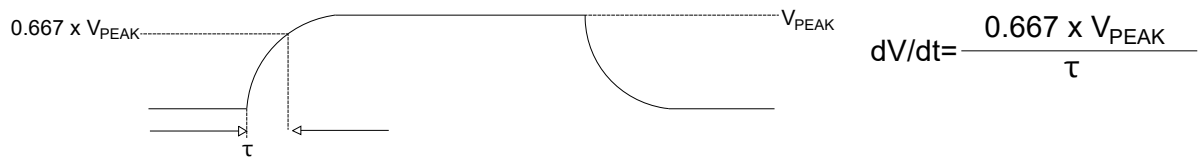
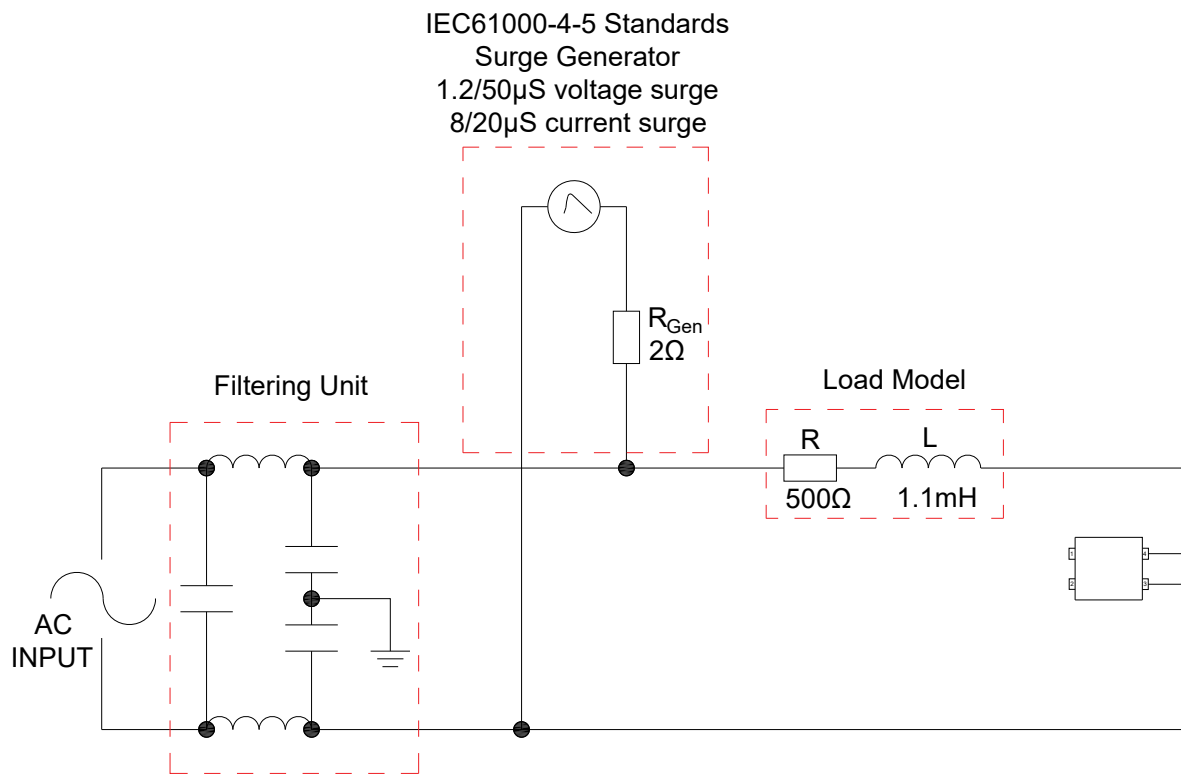
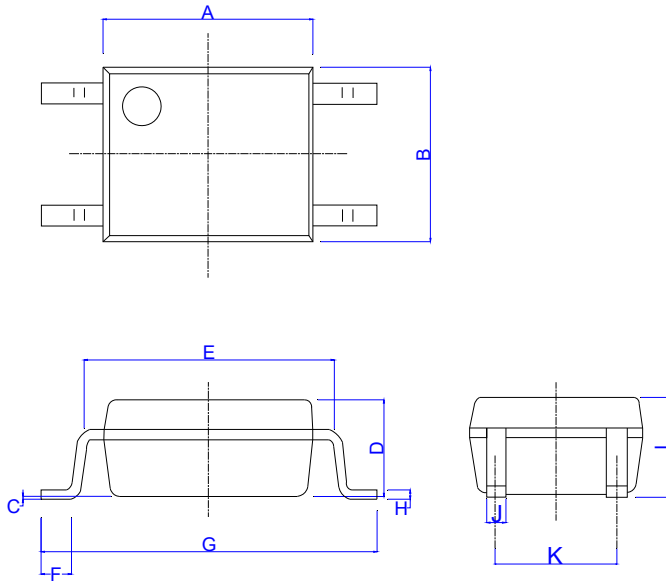

FIG.16: Test circuit for inductive and resistive loads to IEC-61000-4-5 standards



Package Dimension (Unit: mm)



Ref.	Dimensions					
	Millimeters			Inches		
	Min.	Typ.	Max.	Min.	Typ.	Max.
A	4.40		4.80	0.173		0.189
B	3.60		4.20	0.142		0.165
C	0.00		0.20	0.000		0.008
D	1.90		2.30	0.075		0.091
E	5.00		5.60	0.197		0.220
F	0.34		0.94	0.013		0.037
G	6.70		7.30	0.264		0.287
H	0.10		0.30	0.004		0.012
I	2.00		2.40	0.079		0.094
J	0.25		0.55	0.010		0.022
K	2.29		2.79	0.090		0.110

RECOMMENDED SOLDER MASK (Dimensions in mm unless otherwise stated)

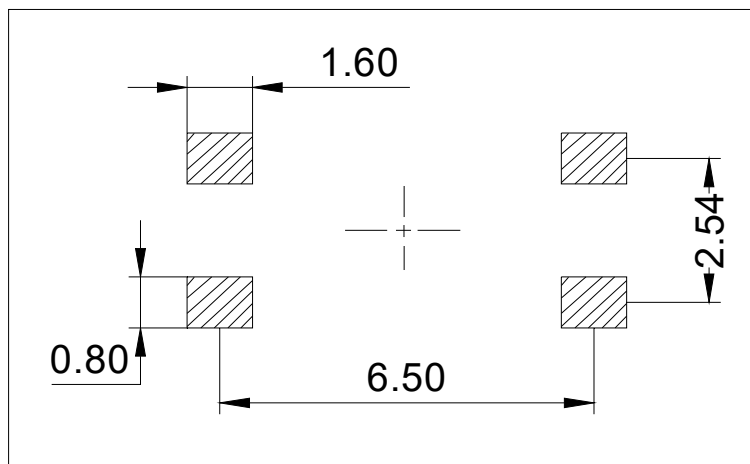

**CARRIER TAPE SPECIFICATIONS (Dimensions in mm unless otherwise stated)**

**Option None**

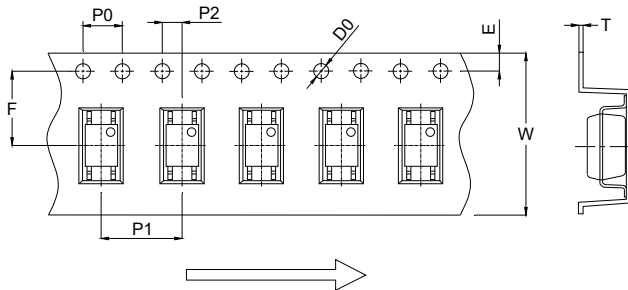

Ref.	Dimensions					
	Millimeters			Inches		
	Min.	Typ.	Max.	Min.	Typ.	Max.
D0		1.50	1.60		0.059	0.063
P0	3.90	4.00	4.10	0.154	0.157	0.161
P1	7.90	8.00	8.10	0.311	0.315	0.319
P2	1.90	2.00	2.10	0.075	0.079	0.083
E	1.65	1.75	1.85	0.065	0.069	0.073
F	7.40	7.50	7.60	0.291	0.295	0.299
T	0.27	0.30	0.33	0.011	0.012	0.013
W	15.80	16.00	16.20	0.622	0.630	0.638

**Option R**

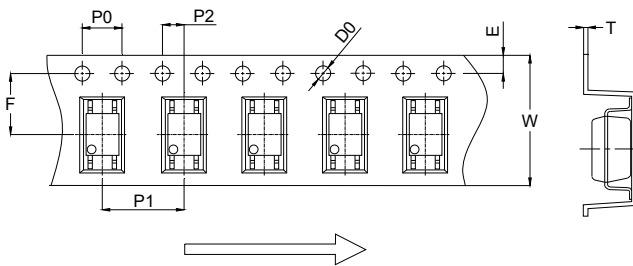

Ref.	Dimensions					
	Millimeters			Inches		
	Min.	Typ.	Max.	Min.	Typ.	Max.
D0		1.50	1.60		0.059	0.063
P0	3.90	4.00	4.10	0.154	0.157	0.161
P1	7.90	8.00	8.10	0.311	0.315	0.319
P2	1.90	2.00	2.10	0.075	0.079	0.083
E	1.65	1.75	1.85	0.065	0.069	0.073
F	4.40	4.50	4.60	0.173	0.177	0.181
T	0.25	0.30	0.35	0.010	0.012	0.014
W	11.90	12.00	12.30	0.469	0.472	0.484

REFLOW INFORMATION



Profile Feature	Sn-Pb Assembly Profile	Pb-Free Assembly Profile
Temperature Min. (T <sub>smin</sub> )	100	150°C
Temperature Max. (T <sub>smax</sub> )	150	200°C
Time (t <sub>s</sub> ) from (T <sub>smin</sub> to T <sub>smax</sub> )	60-120 seconds	60-120 seconds
Ramp-up Rate (t <sub>L</sub> to t <sub>P</sub> )	3°C/second max.	3°C/second max.
Liquidus Temperature (T <sub>L</sub> )	183°C	217°C
Time (t <sub>L</sub> ) Maintained Above (T <sub>L</sub> )	60-150 seconds	60-150 seconds
Peak Body Package Temperature	235°C+0°C/-5°C	260°C+0°C/-5°C
Time (t <sub>P</sub> ) within 5°C of 260°C	20 seconds	30 seconds
Ramp-down Rate (T <sub>P</sub> to T <sub>L</sub> )	6°C/second max.	6°C/second max.
Time 25°C to Peak Temperature	6 minutes max.	8 minutes max.

Note:

1. Reflow soldering is recommended at the temperatures and times shown, no more than three times.
2. Avoid direct contact between the epoxy body and any tools or surfaces exceeding its maximum storage temperature.
3. Application of pressure on the epoxy body is prohibited at elevated temperatures. In specific scenarios, any applied force must not exceed 2.5N.
4. Ensure the component has cooled to ambient temperature before proceeding with any subsequent manufacturing steps.
5. The component has a shelf life of one year when stored under standard conditions.
6. Recommend storage Temp.: 0~40°C;  
Recommend storage humidity: <60%;  
MSL level: MSL 1

Information furnished in this document is believed to be accurate and reliable. However, Jiangsu JieJie Microelectronics Co., Ltd. assumes no responsibility for the consequences of use without consideration for such information nor use beyond it. Information mentioned in this document is subject to change without notice, apart from that when an agreement is signed, Jiangsu JieJie complies with the agreement.

Products and information provided in this document have no infringement of patents. Jiangsu JieJie assumes no responsibility for any infringement of other rights of third parties which may result from the use of such products and information. This document supersedes and replaces all information previously supplied.

 is a registered trademark of Jiangsu JieJie Microelectronics Co., Ltd.

Copyright © 2026 Jiangsu JieJie Microelectronics Co., Ltd. All rights reserved.