



## JCD10SL120B SiC Schottky Diode

Rev.1.0

### DESCRIPTION

- ✧ 1200V Schottky diode
- ✧ Zero reverse recovery current
- ✧ Zero forward recovery voltage
- ✧ High frequency operation
- ✧ Switching characteristics independent of temperature
- ✧ Fast switch
- ✧ Positive temperature coefficient of forward voltage ( $V_F$ )

### BENEFIT

- ✧ Lower switching loss
- ✧ No thermal runaway in parallel devices
- ✧ Lower heatsink dependent

### APPLICATION

- ✧ Switch mode power supplies(SMPS)
- ✧ Boost diodes in PFC or DC/DC stages
- ✧ Free wheeling diodes in inverter stages
- ✧ AC/DC converters

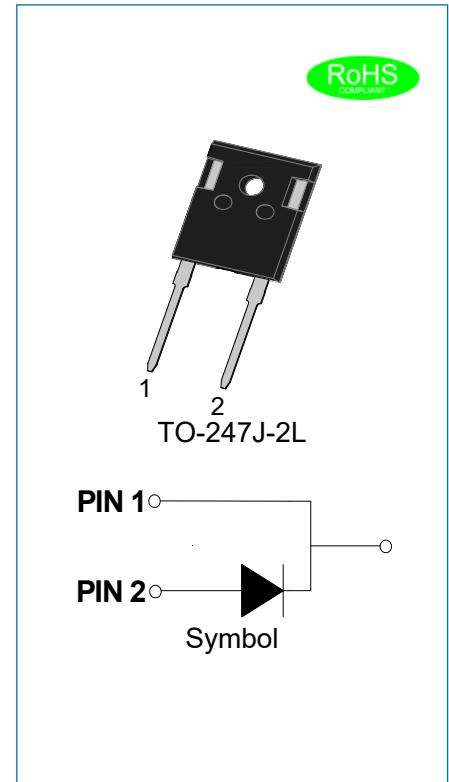

### ABSOLUTE MAXIMUM RATING (Rating at 25°C junction temperature unless otherwise specified.)

Parameter		Symbol	Value	Unit
Maximum repetitive peak reverse voltage		$V_{RRM}$	1200	V
Maximum DC blocking voltage		$V_{DC}$	1200	V
Average forward current	$T_C=158^\circ\text{C}$	$I_{F(AV)}$	10	A
Repetitive peak forward surge current	$t_P=10\text{ms}, T_C=25^\circ\text{C}$	$I_{FRM}$	47	A
Non-repetitive peak forward surge current	$t_P=10\text{ms}, T_C=25^\circ\text{C}$	$I_{FSM}$	95	A
Power dissipation	$T_C=25^\circ\text{C}$	$P_{tot}$	205	W
	$T_C=110^\circ\text{C}$		89	
Operating junction and storage temperature range		$T_J, T_{STG}$	-55 to +175	$^\circ\text{C}$

**ELECTRICAL CHARACTERISTICS** (Rating at 25°C junction temperature unless otherwise specified.)

Parameter	Conditions	Symbol	Value			Unit
			Min.	Typ.	Max.	
Forward voltage	$I_F=10A, T_j=25^\circ C$	$V_F$	-	1.36	1.80	V
	$I_F=10A, T_j=175^\circ C$		-	1.94	-	
Reverse current	$V_R=1200V, T_j=25^\circ C$	$I_R$	-	2	160	$\mu A$
	$V_R=1200V, T_j=175^\circ C$		-	17	-	
Total capacitance	$V_R=1V, f=1MHz$	C	-	560	-	pF
	$V_R=400V, f=1MHz$		-	49	-	
	$V_R=800V, f=1MHz$		-	41	-	
Total capacitance charge	$V_R=800V, T_j=25^\circ C$	$Q_C$	-	53	-	nC
Capacitance stored energy	$V_R=800V$	$E_C$	-	16	-	$\mu J$

**THERMAL CHARACTERISTICS**

Symbol	Parameter	Min.	Typ.	Max.	Unit
$R_{th(j-c)}$	Junction to case	-	0.73	-	$^\circ C/W$

**ORDERING INFORMATION**

<b>J</b> JieJie Microelectronics Co., Ltd SiC Schottky Diode	<b>CD</b> SiC Schottky Diode $I_{F(AV)}=10A$	<b>10</b> $I_{F(AV)}=10A$	<b>SL</b> SL: TO-247J-2L	<b>120</b> $V_{RRM}:1200V$	<b>B</b> Version B
--	--	------------------------------	-----------------------------	-------------------------------	-----------------------

PACKAGE MECHANICAL DATA

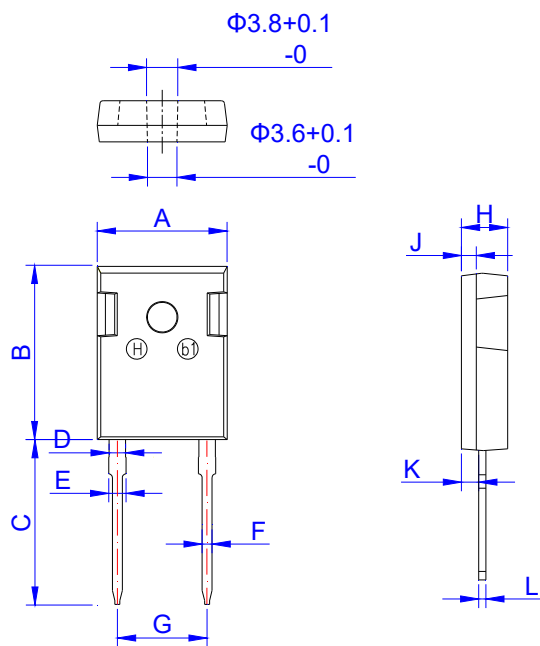

Ref.	Dimensions					
	Millimeters			Inches		
	Min.	Typ.	Max.	Min.	Typ.	Max.
A	15.50	15.80	16.10	0.610	0.622	0.634
B	20.80	21.00	21.20	0.819	0.827	0.835
C	19.70	20.00	20.30	0.776	0.787	0.799
D	1.80	2.00	2.20	0.071	0.079	0.087
E	1.90	2.10	2.30	0.075	0.083	0.091
F	1.00	1.20	1.40	0.039	0.047	0.055
G	10.50		11.30	0.413		0.445
H	4.80	5.00	5.20	0.189	0.197	0.205
J	1.90	2.00	2.10	0.075	0.079	0.083
K	2.20	2.35	2.50	0.087	0.093	0.098
L	0.41	0.60	0.79	0.016	0.024	0.031

CHARACTERISTICS CURVE

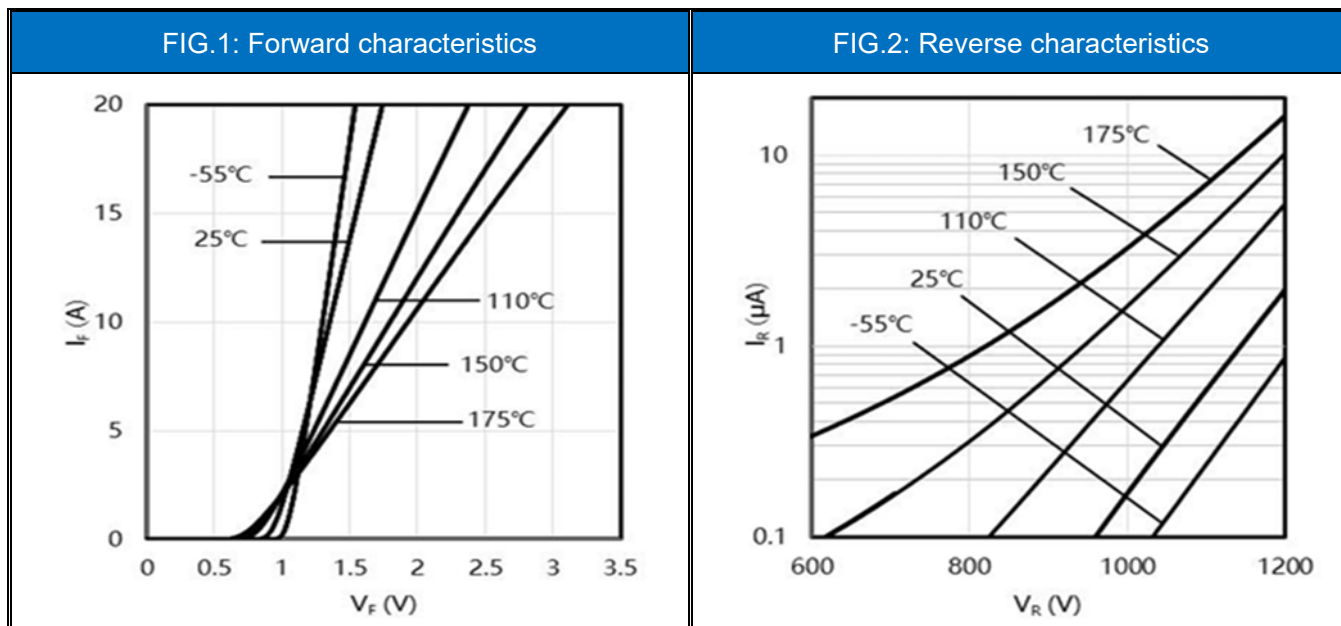

CHARACTERISTICS CURVE

FIG.3: Capacitance vs. reverse voltage

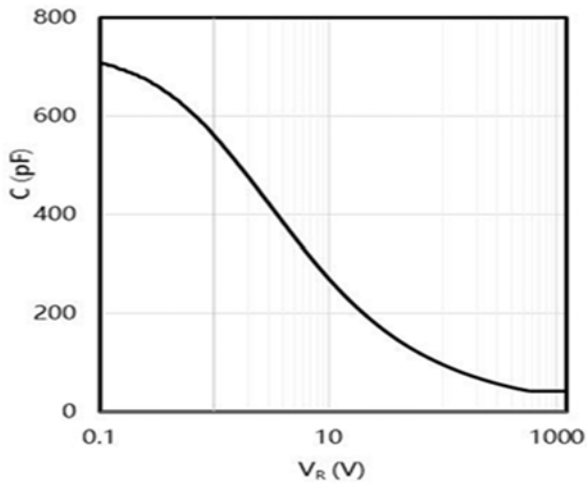

FIG.4: Transient thermal impedance

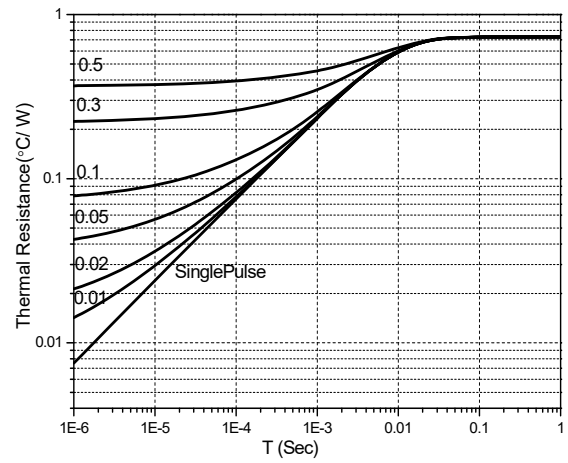

FIG.5: Capacitance charge vs. reverse voltage

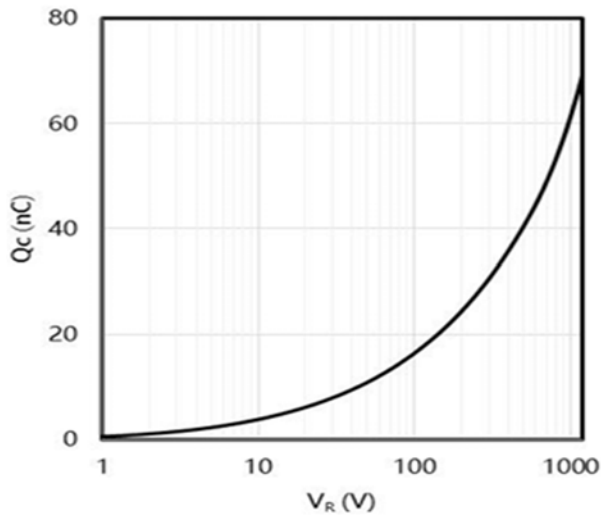

FIG.6: Capacitance stored energy

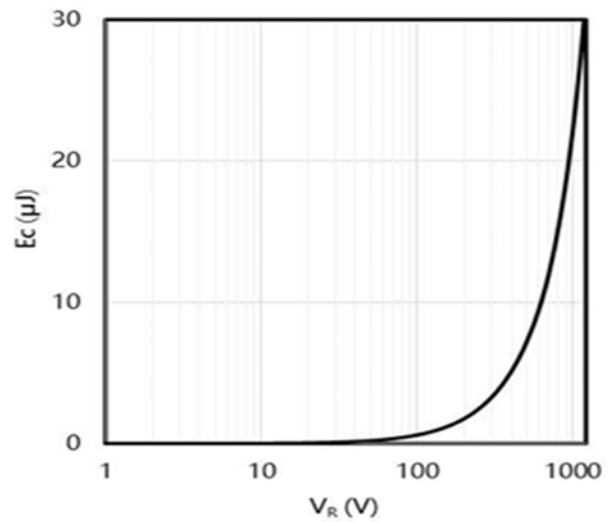
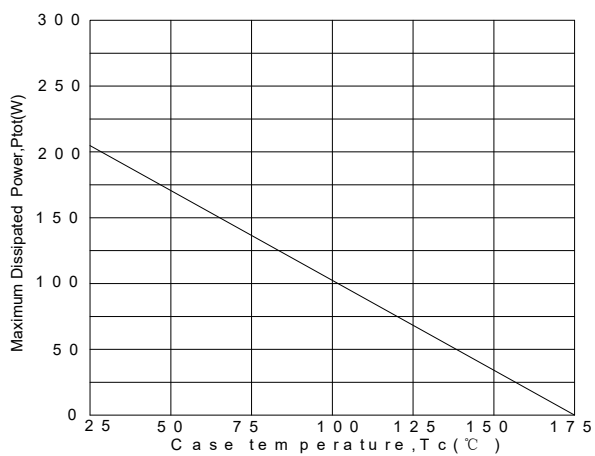

FIG.7: Power derating



JieJie products are not designed for, and shall not be used for, any purpose (including, without limitation, automotive, military, aerospace, medical, life-saving, life-sustaining or nuclear facility applications, devices intended for surgical implant into the body, or any other application in which the failure or lack of desired operation of the product may result in personal injury, death, or property damage) other than those expressly set forth in applicable JieJie product documentation. Warranties granted by JieJie shall be deemed void for products used for any purpose not expressly set forth in applicable JieJie documentation. JieJie shall not be liable for any claims or damages arising out of products used in applications not expressly intended by JieJie as set forth in applicable JieJie documentation. The sale and use of JieJie products is subject to JieJie terms and conditions of sale, unless otherwise agreed by JieJie.

Information furnished in this document is believed to be accurate and reliable. However, Jiangsu JieJie Microelectronics Co., Ltd. assumes no responsibility for the consequences of use without consideration for such information nor use beyond it.

Information mentioned in this document is subject to change without notice, apart from that when an agreement is signed, Jiangsu JieJie complies with the agreement.

Products and information provided in this document have no infringement of patents. Jiangsu JieJie assumes no responsibility for any infringement of other rights of third parties which may result from the use of such products and information.

This document is the first version which is made in 29-May-2026. This document supersedes and replaces all information previously supplied.

 is a registered trademark of Jiangsu JieJie Microelectronics Co., Ltd.

Copyright ©2026 Jiangsu JieJie Microelectronics Co., Ltd. Printed All rights reserved.